

SENTECH

HD 1080p Series Product Specifications



Features

- 1080p HD Resolution
- 60 or 30 FPS
- Direct Connect to Monitor via HDMI
- Wide Dynamic Range

Safety Precautions

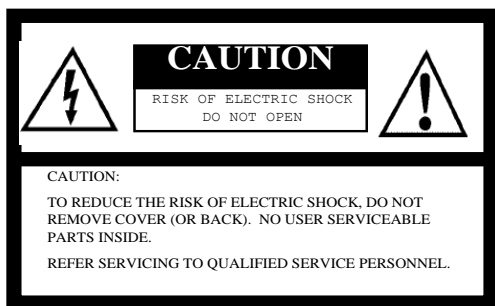

The lightning flash with arrowhead symbol, within an equilateral triangle, is intended to alert the user to the presence of uninsulated “dangerous voltage” within the product’s enclosure that may be of sufficient magnitude to constitute a risk of electric shock to persons.



The exclamation point within an equilateral triangle is intended to alert the user to the presence of important operating and maintenance (servicing) instructions in the literature accompanying the appliance.

For U.S.A.

Warning:

This equipment generates and uses radio frequency energy and if not installed and used properly, I.e., in strict accordance with the instruction manual, may cause harmful interference to radio communications. It has been tested and found to comply with the limits for a Class A computing device pursuant to Subpart J of Part 15 of FCC Rules, which are designed to provide reasonable protection against such interference when operated in a commercial environment.

For Canada

Warning:

This digital apparatus does not exceed the Class A limits for radio noise emissions from digital apparatus set out in the Radio Interference Regulations of the Canadian Department of Communications.

WARNING:

TO PREVENT FIRE OR SHOCK HAZARD, DO NOT EXPOSE THIS APPLIANCE TO RAIN OR MOISTURE.

Product Precautions

- Handle the camera with care. Do not abuse the camera. Avoid striking or shaking it. Improper handling or storage could damage the camera.
- Do not pull or damage the camera cable.
- During camera use, do not wrap the unit in any material. This will cause the internal temperature of the unit to increase.
- Do not expose the camera to moisture, or do not try to operate it in wet areas.
- Do not operate the camera beyond its temperature, humidity and power source ratings.
- While the camera is not being used, keep the lens or lens cap on the camera to prevent dust or contamination from getting in the CCD or filter area and scratching or damaging this area.
- Do not keep the camera under the following conditions:
 - In wet, moist, and high humidity areas
 - Under hot direct sunlight
 - In high temperature areas
 - Near an object that releases a strong magnetic or electric field
 - Areas with strong vibrations
- Use a soft cloth to clean the camera. Use pressured air spray to clean the surface of the glass. DO not scratch the surface of the glass.

Copyright & Disclaimer

Sensor Technologies America, Inc. (DBA Sentech America) believes the contents and specifications of its website, catalog, documentation and ads are correct; however, Sentech America provides no representation or warranty regarding such information or product(s) contained therein. It is requested that Sentech America be given appropriate acknowledgement in any subsequent use of such work by a third party.

While every effort has been made to ensure that the details contained in Sentech America's website and all documentation are correct and up-to-date, Sentech America assumes no liability, legal or otherwise for any errors in listings, specifications, part numbers, process, software or model applications. Sentech America reserves the right to change specifications, product descriptions, product quality, pricing and application at any time without prior written or oral notice. Any party using such information assumes all risk for any and all damaged caused to themselves, a third party and/or property by virtue of incorrect information and/or failure of these products. By installing and/or using a Sentech America software development kit or other similar product and/or information obtained from Sentech America's website, catalog, documentation or ads, you hereby accept and understand these stated terms and conditions.

Table of Contents

1 Introduction	4
1.1 Features	4
1.2 Naming Method	4
1.3 Peripheral Equipment	4
2 Specifications	5
2.1 General Specifications	5
2.1.1 Spectral Sensitivity Characteristics	6
2.2 External Control Specification.....	7
3 Dimensions.....	8
3.1 STC-HD203DV.....	8
3.2 STC-HD203SDI.....	9
4 Control Software User's Guide	10
4.1 Requirements.....	10
4.2 Basic Operating Procedure	10
4.3 Button Description.....	11
4.4 Differences between the uCOM and DSP Register.....	11
4.5 Functional Description	12
5 Communication Protocol Specifications.....	25
5.1 Communication Settings.....	25
5.2 Communication Format	25
5.3 Camera Control Commands.....	26
5.3.1 Command List for the Communication.....	26
5.3.2 Slave Address for the ICS (8bit) list	28
5.3.3 Error Code List.....	28
5.4 The uCOM Register Mapping List	29
5.4.1 Push Button Function Menu	33
5.4.2 Push Button Function List	33
5.5 The DSP Register Mapping List	34
5.6 OSCD (On Screen Display) Command	46
5.6.1 2Byte Command.....	46
5.6.2 2 Byte Consecutive Command	47

1 Introduction

This documentation describes the specifications of the following cameras:

[DVI Output]

STC-HD203DV (C-Mount Cased Type)

[SDI Output]

STC-HD203SDI (C-Mount Cased Type)

1.1 Features

- 1080p CMOS Sensor
- DVI / SDI Output
- On Screen Display through remote control (optional)
- Configurable parameters through Control Software
- Eight Configurable DSPs
- Wide Dynamic Range (ATR-EX)

1.2 Naming Method

STC-HD203xx



Back Panel
DV: DVI Output
SDI: SDI Output

1.3 Peripheral Equipment

The following peripheral equipment can be provided by Sentech (optional):

- Remote Control: RC-HD133
- +12V DC Power Supply: UN310-1210
- Communication Tool (PC can communicate with the camera through the USB port): JIG-USB-HD
- Control Software (JTACtrl)

2 Specifications

2.1 General Specifications

Product		STC-HD203**(Cased type)		
Electronic specifications	Imager	1/2.8" 230Mega pixel CMOS (SONY: IMX136), Rolling Shutter		
	Active picture elements	1936 (H) x 1096(V)		
	HD active picture elements	1920 (H) x 1080 (V)		
	Optical size	5.44 (H) x 3.09 (V) mm		
	Cell size	2.8 (H) x 2.8 (V) μm		
	Sync system	Progressive		
	Minimum scene illumination	TBD Lux (AGC ON)		
	Sync. System	Internal		
	Video output	DVI Model	DVI 1.0 conformity RGB, 1080P60,1080P59.94, 1080P50, 1080P30,1080P29.97, 1080P25, 720P60, 720P59.94, 720P50 (Default:1080P60)	
		SDI Model	3G-SDI(SMPTE424M Compliant), 4:2:2 YCbCr 10bit 1080P60/59.94/50 HD-SDI (SMPTE292M Compliant) 4:2:2 YCbCr 10bit 1080P30/29.97/25 720P60/59.94/50	
	Camera functions	ALC	Can be configured via the UART communication with auto electronic shutter and AGC	
		Shutter speed	Adjustable shutter speed via the UART communication (AEE) (Default: Auto)	
			Extended	Extend shutter frame unit (Up to 2.55 sec)
			High speed	Up to 1/10,000 seconds
		Gain	AGC or Fixed gain selectable via the UART communication 0 to 45 dB	
		Gamma	Selectable gamma through 5 preset (one preset is manual, / 0.45 / 0.6 / 0.8 / 1) Selectable gamma via the UART communication (Default: manual)	
		White balance	Auto white balance / manual white balance / push to set white balance Selectable white balance via the UART (Default: Auto white balance)	
		WDR	Wide Dynamic Range OFF/ON (Default:OFF) WDR enable via the UART communication	
		Mirror image	Normal image / horizontal flip / vertical flip / horizontal vertical flip(180 degree rotation) Default: Normal image	
		Picture modes	8 user preset mode, Normal picture mode or pseudo color mode can be selectable Selectable picture mode via the UART communication (Default: Preset 0)	
		Line generator	Both horizontal and vertical with all available colors (Line number: 2) Adjustable thickness via the UART communication (Default: Disable)	
		Shadow mask generator	Both horizontal and vertical with shading level adjustment via the UART communication(Default: Disable)	
		Freeze image	Selectable Live image or freeze image via the UART communication	
Communication		+3.3V UART communication via 3.5Φ stereo jack (Baud rate: 38,400bps, 19,200bps, 9,600bps)		
Character generator		Built-in character generation function via the UART communication		
Pixel blemish collection	Support			
Power	Input voltage	+9 to +15 Vdc (Typical: +12 Vdc)		
	Consumption	4.4W (preliminary)		
Mechanical specifications	Dimensions	40 (W) x 40 (H) x 51.1(D) mm (Excluding the connector)		
	Optical filter	IR cut filter with OPLF		
	Material	Aluminum (AC)		
	Lens mount	C mount (Recommendation F: more than 2.0))		
	Interface connector	Video output	DVI Output : HDMI connector, SDI Output : BNC connector	
		Power input	+9 to +15 Vdc (Typical: +12 Vdc)	
		External control Communication	3.5Φ stereo jack with SW board 3.5Φ stereo jack	
Weight	Approximately 116g			
Environmental specifications	Operational temperature	-0 to 40 deg. C		
	Storage temperature	-30 to 65 deg. C		
	Vibration	20Hz to 200Hz to 20Hz (5min./cycle), acceleration 10G, XYZ 3 directions 30 min. each)		
	Shock	Acceleration 38G, half amplitude 6ms, XYZ 3 directions 3times each		
	Standard compliancy	EMS: EN61000-6-2, EMI: EN55022 (Class B)		
	RoHS	RoHS compliance		

2.1.1 Spectral Sensitivity Characteristics

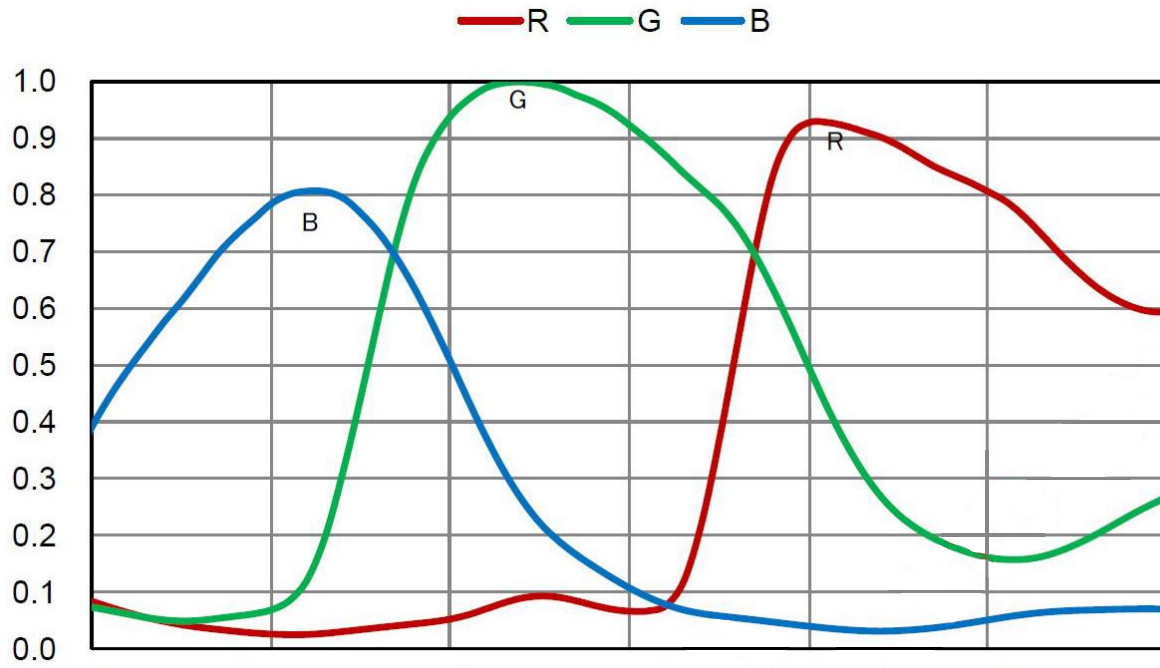

2.2 External Control Specification

The following is a circuit diagram of the SW Board to connect the 3.5Ø Stereo Pin Jack

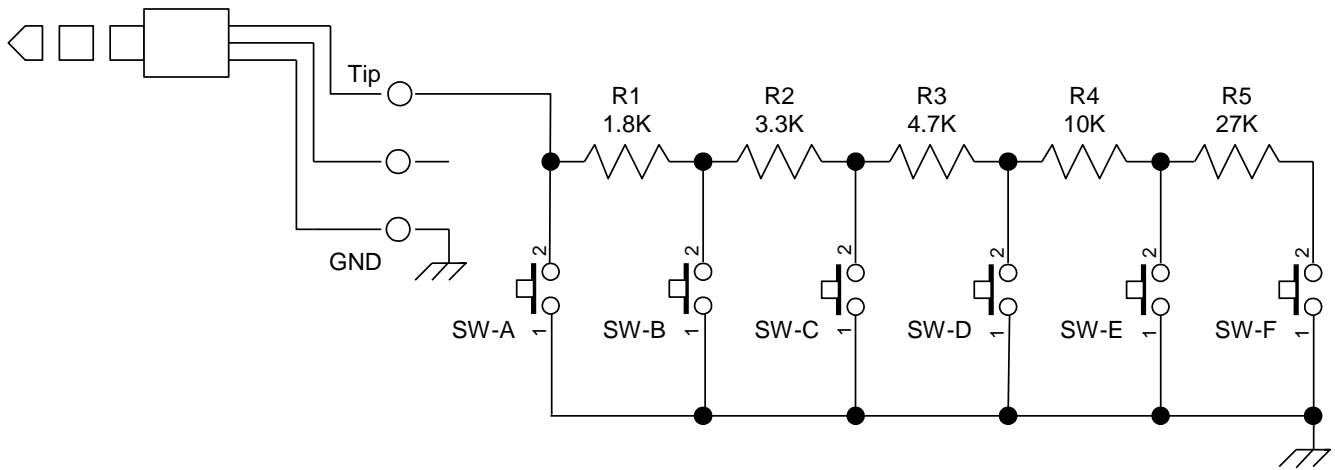

3 Dimensions

3.1 STC-HD203DV

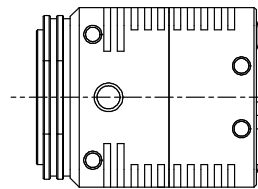
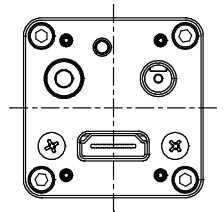
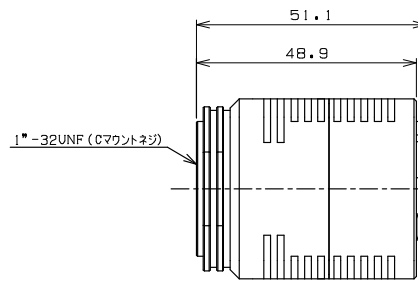
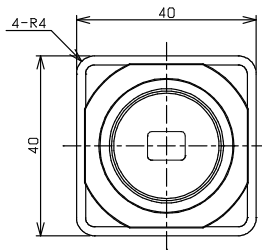
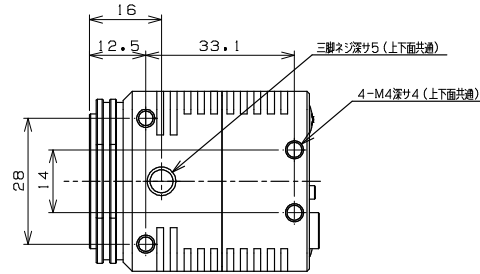
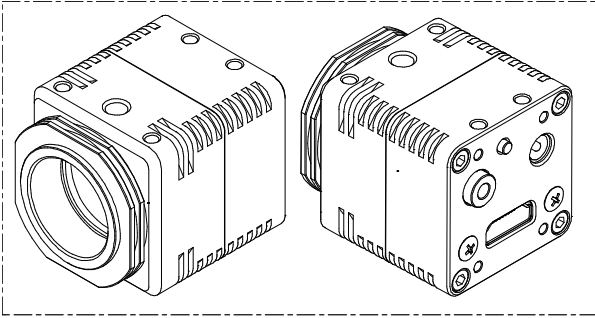

Unit: mm

3.2 STC-HD203SDI

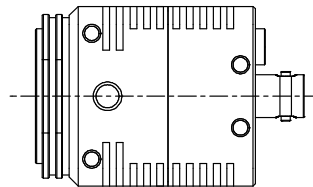
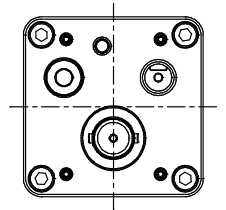
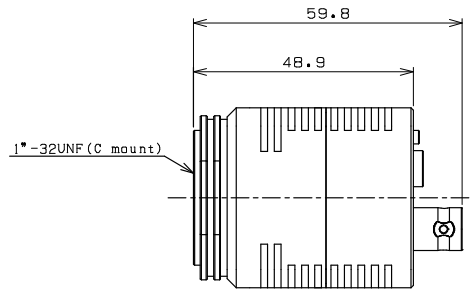
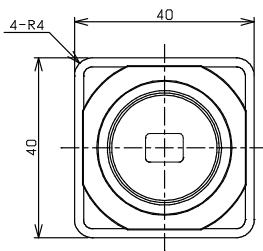
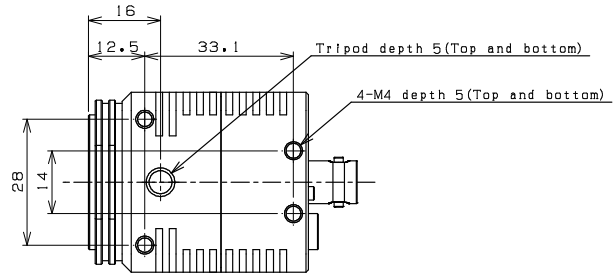
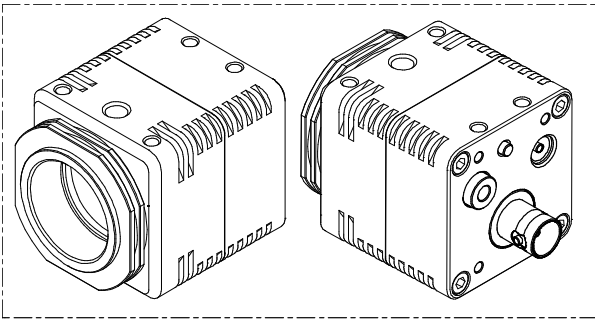

Unit: mm

4 Control Software User's Guide

4.1 Requirements

- +12V DC Power Supply
- Remote Control
- Communication Tool
- Control Software

4.2 Basic Operating Procedure

- Connect the power supply with the camera, as well as connecting the Communication tool with the PC via USB cable.
- After JTA Ctrl has been installed, the control software can be launched from JTACtrl.exe

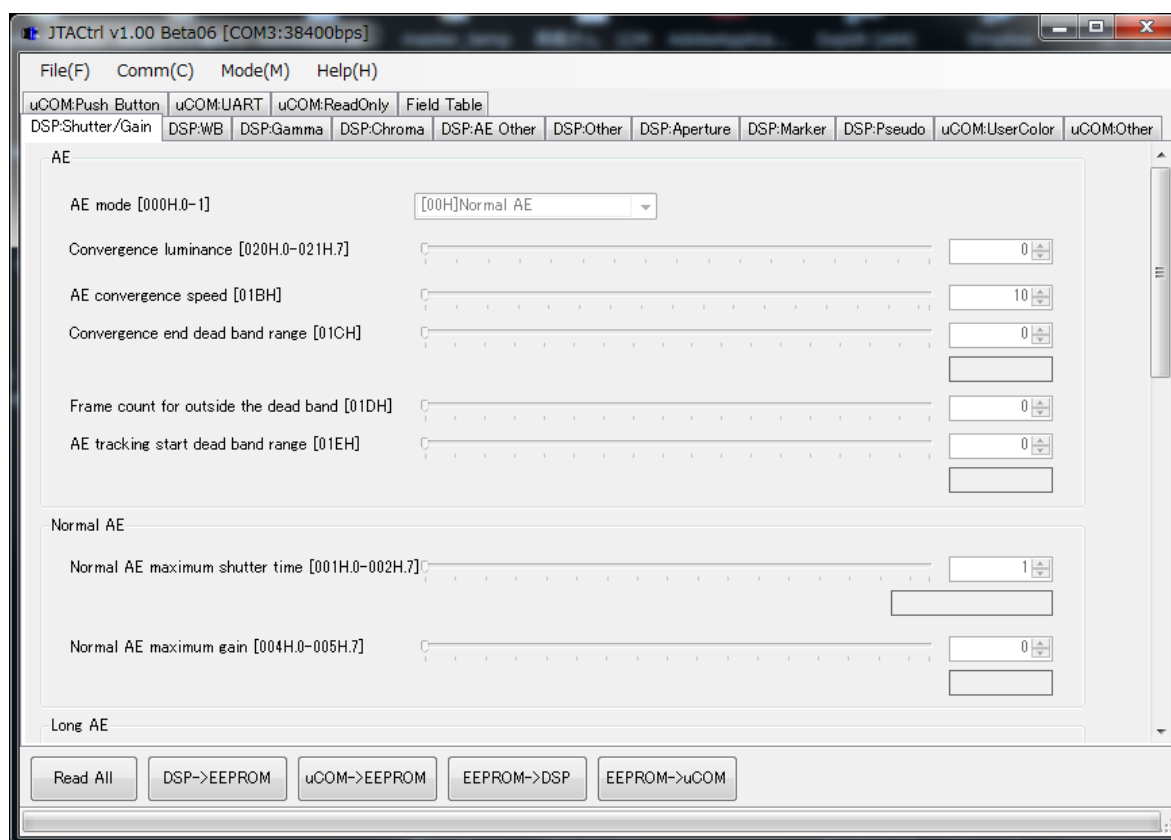

- Select the COM port number through COMM(C) → Port Setting
- Click Read All to read all of the register values from the camera.
- All of the camera settings can be configured through the control software.

4.3 Button Description



Read All

Read out All of the DSP register and the uCOM register values on the camera. Please execute this command every time the camera is started up.

DSP → EEPROM

Save the DSP register values into the EEPROM

uCOM → EEPROM

Save the uCOM register values into the EEPROM

EEPROM → DSP

Read the DSP register values on the EEPROM

EEPROM → uCOM

Read the uCOM register values on the EEPROM

4.4 Differences between the uCOM and DSP Register

The main difference is that the DSP register is mainly where video control functions are stored along with the eight User Presets that the user can load for different applications. The uCOM is primarily used for communication and other functions.

4.5 Functional Description

DSP: Shutter/GainTab

AE

AE

AE mode [000H.0-1] [00H]Normal AE

Convergence luminance [020H.0-021H.7] 4608

AE convergence speed [01BH] 32

Convergence end dead band range [01CH] 26

0.15[dB]

Frame count for outside the dead band [01DH] 8

AE tracking start dead band range [01EH] 4

0.38[dB]

AE mode

Normal AE, Long AE, USER Mode can be selectable. If User likes to use Fixed Gain, Fixed Shutter, USER mode should be selected. If User likes to use Auto Gain or Auto Shutter, Normal AE, Long AE should be selected on Priority Mode.

Convergence luminance

This setting is target luminance at which AE has converged to the appropriate luminance.

AE convergence speed

This setting is used to set the time to be taken for the exposure amount appropriate for the image to be established.

Convergence end dead band range

This setting is used to set the range in which convergence is to be identified.

Frame count for outside the dead band

When the absolute value of the error amount is below the setting and the same status has continued for frame number.

AE tracking start dead band range

This function is used to ensure that the AE operation will not overly respond to changes in the subject when an object has passed cut across the shooting screen while AE is in the appropriate status. Tracking is started when the AE error amount is above the setting and this has continued for at least the number of outside the dead band frame number.

Normal AE

Normal AE

Normal AE maximum shutter time [001H.0-002H.7]
 20.0[ms], 1/50.0[s]

Normal AE maximum gain [004H.0-005H.7]
 42.0[dB]

Long AE

Long AE

Long AE normal shutter time [006H.0-007H.7]
 16.6[ms], 1/60.2[s]

Long AE expanded shutter time [008H.0-009H.7]
 33.3[ms], 1/30.0[s]

Long AE maximum shutter time [00AH.0-00BH.7]
 150.0[ms], 1/6.7[s]

Long AE low gain [00CH.0-00DH.7]
 26.1[dB]

Long AE high gain [00EH.0-00FH.7]
 36.0[dB]

Long AE maximum gain [010H.0-011H.7]
 42.0[dB]

Priority Mode

Priority Mode

Gain priority [028H.0-4] [00H]No priority

Shutter priority [029H.0-02AH.7]
 OFF 1/5 1/10 1/20 1/25 1/30 OFF
 1/50 1/60 1/100 1/120 1/200 1/500

When Normal AE or Long AE is selected on AE Mode, this setting might be reflected. If User likes to use Fixed Gain or Fixed Shutter, this Priority Mode should be selected.

USER Mode



When User likes to use Fixed Gain or Fixed Shutter, this mode can be used when USER mode is selected on AE mode.

DSP: WB

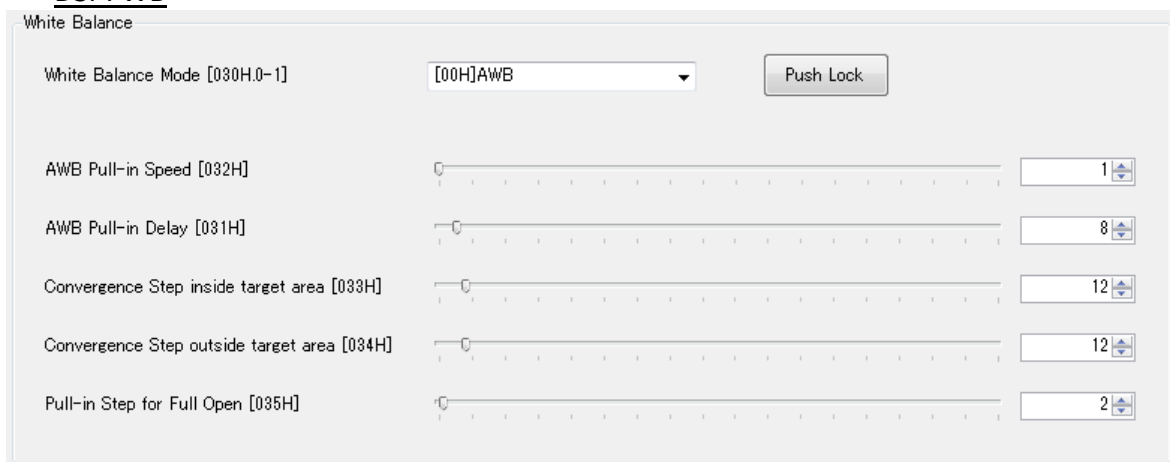

White Balance

AWB, Full-Open, AWB Hold, USER Mode can be selectable. When User likes to use Fixed White Balance, please select USER Mode.

AWB Pull-in Speed

Pull-in speed of AWB mode is set in the number of frames specified by this setting. This setting might be available when Auto or Full Open is selected on White Balance Mode. Unit: Frame number

AWB Pull-in Delay

When a status outside the dead band has been detected in the AWB mode, pull-in is started after achieving consistency in the number of frames specified by this setting. Unit: Frame number

Convergence Step inside target area

The AWB pull-in steps inside target area can be indicated. When set step shortly, the convergence speed of white balance is faster.

Convergence Step outside target area

The AWB pull-in steps outside target area can be indicated. When set step shortly, the convergence speed of white balance is faster.

Pull-in Step for Full Open

When set the number of steps for full open mode pull-in, the convergence speed is faster.

USER Mode

USER Mode

User Mode fixed coordinate R/G [036H.0-037H.7]

User Mode fixed coordinate B/G [038H.0-039H.7]

When White Balance mode is on USER mode. Fixed White Balance can be set.

DSP: Gamma

Gamma

Gamma Mode [043H.0-2]

Gamma Output Selection [043H.3-4]

Gamma Curve

Manual Gamma

Gamma KNOT00 <input type="text" value="408"/>	Gamma KNOT14 <input type="text" value="1088"/>
Gamma KNOT01 <input type="text" value="432"/>	Gamma KNOT15 <input type="text" value="1168"/>
Gamma KNOT02 <input type="text" value="464"/>	Gamma KNOT16 <input type="text" value="1240"/>

Gamma Mode

Manual or Preset value (0.45,0.6,0.8,1.0) can be selected. When Manual is selected, Gamma curb that was defined on Manual Gamma part are reflected.

Gamma Output Selection

Gamma Converted Output or Gamma un-Converted Output can be selected. When Gamma Converted Output is selected, Output video image output from Gamma Mode's value.

DSP: Chroma

Chroma

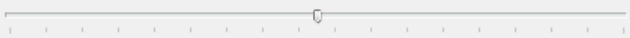
Hue Adjustment [07CH] 

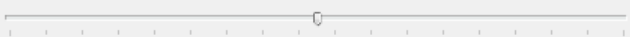
Saturation Adjustment [07DH] 

Hue Adjustment

The hue can be adjusted.

Saturation Adjustment

The Saturation can be adjusted.

DSP: AE Other

Flickerless mode

Flickerless mode [01AH.0-2]

Photometry mode

Photometry mode [080H.0]

Weight photometry

5	8	10
11	13	11
10	8	5

0frame coefficient [081H] 

1frame coefficient [082H] 

2frame coefficient [083H] 

3frame coefficient [084H] 

4frame coefficient [085H] 

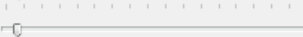
5frame coefficient [086H] 

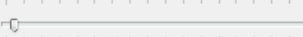
6frame coefficient [087H] 

7frame coefficient [088H] 

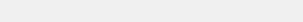
8frame coefficient [089H] 

Flickerless mode

Flicker is generated when shooting under fluorescent lights whose flickering periods differ from the shutter periods. This is function capable of reducing the flicker by adjusting the shutter speed(Auto,50Hz,60Hz) so as to match the light-emitting frequency of the fluorescent lights.

Photometry mode

In order to achieve the optimum luminance, this photometry mode automatically adjusts the gain value and exposure time to achieve the optimum luminance level by detecting the luminance signals in the screen region using 9 frames (3 horizontal x 3 vertical frames) and giving weighting to this region on the screen or, alternatively, it adds up the total number of luminance levels, measures the histograms and gives weight to them. Among the former modes are the average photometry, weighted photometry modes.

DSP: Other

The screenshot displays the 'DSP: Other' settings interface. It contains the following items:

- Resolution/FrameRate [040H.0-3]:** A dropdown menu set to '[00H]1080p 60fps'.
- Image Output Inversion [041H.0-1]:** A dropdown menu set to '[00H]Standard'.
- Sharpness Gain [07EH]:** A horizontal slider with a value of 64 displayed in a box on the right.
- ATR-EX function [07FH.0]:** A dropdown menu set to '[00H]OFF'.
- Color/Black and white [12AH.7]:** A dropdown menu set to '[00H]Color'.
- Contrast [129H]:** A horizontal slider with a value of 128 displayed in a box on the right.
- RGB offset [12AH.0-6]:** A horizontal slider with a value of 0 displayed in a box on the right.

Resolution/FrameRate

Select the output video format.

Image Output Inversion

Select the H,V Inversion image.

Sharpness Gain

Set the Sharpness value.

ATR-EX function

When both low-luminance areas and high-luminance areas exist on one screen, AE controls the exposure in such a way that the exposure is appropriate for the high-luminance areas, loss of dark detail will occur; conversely, overexposure will occur if AE controls the exposure so that it is appropriate for the low-luminance areas. This happens because the luminance of images tends toward either the high-luminance side or low-luminance side. Both overexposure and loss of dark detail can be avoided and images with the appropriate contrast can be achieved by compressing the low- and high-luminance areas for the image components in one field toward medium luminance and compensating the high-visibility medium-luminance areas toward the appropriate gray scale. The function used to achieve this is called ATR-EX (Augmenting Tone Reproduction) or WDR (Wide Dynamic Range).

Color/Black and white

Select the Color or Monochrome image..

Contrast

Set the Contrast value.

RGB offset

Set the offset on Video image.

DSP: Aperture

Back Aperture

Aperture H. gain in back process [12BH.0-3]	<input type="text"/>	<input type="text" value="0"/>	<input type="text" value="0.00"/>
Aperture V. gain in back process [12BH.4-7]	<input type="text"/>	<input type="text" value="0"/>	<input type="text" value="0.00"/>
Aperture coring in back process [12CH.0-5]	<input type="text"/>	<input type="text" value="0"/>	<input type="text"/>

The aperture compensation function is used to enhance the perceived resolution by emphasizing the edge areas of the images. To emphasize the edges, increase the aperture compensation gain value. However, if this gain is increased too much, noise which manifests as a roughness of the images becomes noticeable. Adjust the parameter changes while monitoring the actual images.

DSP: Marker

Set the Horizontal/Vertical line marker and shadow.

Marker

Marker [100H.7]	<input type="text" value="[01H]Enabled"/>
-----------------	---

Marker

Set the line marker and shadow.

Line Marker

Line marker [100H.0]	[01H]Enabled	
Horizontal line1 marker color [10AH.4-7]	[00H]Black	
Horizontal line1 marker position [10BH.0-10CH.2]	<input type="text" value="0"/>	
Horizontal line1 marker thickness [10DH.0-10EH.2]	<input type="text" value="0"/>	
Vertical line1 marker color [10AH.0-3]	[00H]Black	
Vertical line1 marker position [10FH.0-110H.2]	<input type="text" value="0"/>	
Vertical line1 marker thickness [111H.0-112H.2]	<input type="text" value="0"/>	
Horizontal line2 marker color [113H.4-7]	[00H]Black	
Horizontal line2 marker position [114H.0-115H.2]	<input type="text" value="0"/>	
Horizontal line2 marker thickness [116H.0-117H.2]	<input type="text" value="0"/>	

Line Marker

Set the color, position, size of two line markers.

Shadow Mask

Shadow mask [100H.1]	[01H]Enabled	
Shadow mask shading level [101H]	<input type="text" value="0"/>	
Horizontal shadow mask top position [102H.0-103H.2]	<input type="text" value="0"/>	
Horizontal shadow mask bottom position [104H.0-105]	<input type="text" value="1080"/>	
Vertical shadow mask left position [106H.0-107H.2]	<input type="text" value="0"/>	
Vertical shadow mask right position [108H.0-109H.2]	<input type="text" value="1920"/>	

Shadow Mask

Set the shadow mask on top, bottom, left, right side.

DSP: Pseudo

Picture mode selection [125H.0]

Background pseudo color [126H.0-3] abc

Overlay graphics pseudo color [126H.4-7]

Normal color mode shadow mask line color [125H.1]

Pseudo color threshold [127H]

Pseudo color slope [128H]

Picture mode selection

Select the Normal color or Pseudo color mode. When Pseudo is selected, bipolarization video image is output.

Background pseudo color

Convert the brighter image into selected color.

Over graphics pseudo color

Convert the darker image into selected color.

Normal color mode shadow mask line color

Select the line color of shadow mask from black or Over graphics pseudo color.

Pseudo color threshold

Set the threshold to bipolarize the input video image.

Pseudo color slope

Set the slope of bipolarization.

uCOM: User Color

User defined color 0 R [010H]	0	<input type="text" value="255"/>
User defined color 0 G [011H]		<input type="text" value="128"/>
User defined color 0 B [012H]		<input type="text" value="0"/>
User defined color 1 R [013H]	1	<input type="text" value="255"/>
User defined color 1 G [014H]		<input type="text" value="0"/>
User defined color 1 B [015H]		<input type="text" value="128"/>
User defined color 2 R [016H]	2	<input type="text" value="128"/>
User defined color 2 G [017H]		<input type="text" value="255"/>
User defined color 2 B [018H]		<input type="text" value="0"/>

Define the eight color table. The defined color can be used as Pseudo color.

uCOM: Other

User Preset

UserPreset [000H.0-2]

User Preset

Set the DSP setting from eight Preset0 to Preset7. All of DSP setting parameter may reflect after readout.

Digital Zoom

Digital zoom [056H]

Digital zoom pan [058H.0-059H.2]

Digital zoom tilt [05AH.0-05BH.2]

Digital Zoom

Set the Digital Zoom.

Digital zoom pan

Set the offset on horizontal direction.

Digital zoom tilt

Set the offset on vertical direction.

OSD

OSD menu color [050H.0-2]	<input type="text" value="[07H]White"/>	
OSD character size [050H.3]	<input type="text" value="[00H]Large"/>	
OSD horizontal position [051H]	<input type="text" value="0"/>	
OSD vertical position [052H]	<input type="text" value="0"/>	
OSD RGB level [053H]	<input type="text" value="186"/>	
OSD Edge level [054H]	<input type="text" value="16"/>	

Set the OSD function, actual OSD control can be through remote controller.

Other

Still image [055H.0]	<input type="text" value="[00H]OFF"/>
Test pattern selection [055H.1-2]	<input type="text" value="[00H]OFF"/>

Still image

Set the Still video image.

Test pattern selection

Set the test pattern on video output.

uCOM: Push Button

Button

Push button activation [00EH.0]	<input type="text" value="[01H]Enable"/>
Menu: page increment [028H.4-7]	<input type="text" value="[09H]WB"/>
Menu: down [029H.0-3]	<input type="text" value="[0FH]F"/>
Menu: up [029H.4-7]	<input type="text" value="[0BH]B"/>
Menu: right [02AH.0-3]	<input type="text" value="[0EH]E"/>
Menu: left [02AH.4-7]	<input type="text" value="[0CH]C"/>
Menu: turn off [02BH.0-3]	<input type="text" value="[0AH]A"/>
Menu: enter [02BH.4-7]	<input type="text" value="[0DH]D"/>

Single push/Hold can be assigned on remote controller's push button.

Marker shadow

Horizontal line Min. position(for push button) [05CH.0-05DH.2]		0
Horizontal line Max. position(for push button) [05EH.0-05FH.2]		1920
Horizontal line Max. thickness(for push button) [060H.0-061H.2]		1920
Vertical line Min. position(for push button) [062H.0-063H.2]		0
Vertical line Max. position(for push button) [064H.0-065H.2]		1080
Vertical line Max. thickness(for push button) [066H.0-067H.2]		1080
Shadow Horizontal Min. position [068H.0-069H.2]		0
Shadow Horizontal Max. position [06AH.0-06BH.2]		1920
Shadow Vertical Min. position [06CH.0-06DH.2]		0
Shadow Vertical Max. position [06EH.0-06FH.2]		1080

Remote controller can set the Marker and Shadow parameters.

Push button (single push/hold)

Primary switch function: single push [039H]	[02H]PushLock WB[Save]
Primary switch function: hold [049H]	[03H]WBMode(AWB)[Save]
External switch A function: single push [03AH]	[01H]Display Menu
External switch A function: hold [04AH]	[00H]Disabled
External switch B function: single push [03BH]	[00H]Disabled
External switch B function: hold [04BH]	[00H]Disabled
External switch C function: single push [03CH]	[00H]Disabled
External switch C function: hold [04CH]	[00H]Disabled
External switch D function: single push [03DH]	[00H]Disabled
External switch D function: hold [04DH]	[00H]Disabled
External switch E function: single push [03EH]	[00H]Disabled
External switch E function: hold [04EH]	[00H]Disabled
External switch F function: single push [03FH]	[00H]Disabled
External switch F function: hold [04FH]	[00H]Disabled

Allows the user to select the function for each button.

uCom: UART

UART

UART baud rate [00FH.0-1] [02H]38400bps ▼

UART short reply for write [00FH.6] [00H]Disable ▼

UART check sum [00FH.7] [01H]Enable ▼

Allows the user to set the camera communication.

uCom: ReadOnly

Firmware version [380H.0-381H.7] 5 [0005]

FPGA version [382H.0-383H.7] 7 [0007]

Allows the user to read the Firmware and FPGA revision on the camera.

Field: Table

ShutterGain ▼ Tab Page Filter Different Filter

Device	TabPage	Address	Name	EEPROM	Register
DSP	ShutterGain	000H.0-1	AE mode	[00H]Normal AE	[00H]Normal AE
DSP	ShutterGain	001H.0-002H.7	Normal AE maximum shutter time	200	200
DSP	ShutterGain	004H.0-005H.7	Normal AE maximum gain	140	140
DSP	ShutterGain	006H.0-007H.7	Long AE normal shutter time	166	166
...

This functions shows all of the register settings from the registers.

5 Communication Protocol Specifications

5.1 Communication Settings

Setting	Value
Baud rate	9,600 bps / 19,200 bps / 38,400 bps (Default)
Data bit	8 bits
Parity	None
Stop bit	1 bit
Flow control	None

5.2 Communication Format

The format for sending and receiving data between the PC and the camera is shown below:

SOF 8 bits	Command 8 bits	Direction 1 bit	Data length 15 bits	Data [Data length] byte (Variable)	Check sum 8 bits	EOF 8 bits
---------------	-------------------	--------------------	------------------------	--	---------------------	---------------

Details of the format:

	Details
SOF	Start of the Frame. This value is always "0x02".
Command	Command Code Refer to: "The Camera Control Command"
Direction	"0": Reading or receiving data from the camera is always a "0" value. "1": Writing or sending data to the camera is always a "1" value. Note: This value is always "0" when the Camera responds.
Data length	This "Data Length" value tells how many bytes the "Data" will contain. The "Data Length" must be specified in bytes.
Data	This field is for option, set value and/or acquired value. The size must be specified as "Data Length".
Check sum	The "Check sum" functions to verify the integrity of the communication transmission. The "Check sum" value should equal the last (low) 8 bits of the summary of ["Command" + "Direction" + "Data Length" + "Data"]. If this value of "Check sum" does not match with last (low) 8 bits of the summary data of ["Command" + "Direction" + "Data Length" + "Data"], the camera will generate the error message: "Check Sum Error".
EOF	End of the Frame. This value is always "0x03".

5.3 Camera Control Commands

All data in this section is described in hexadecimal format (HEX).

5.3.1 Command List for the Communication

Command (HEX)	Command details
4A	<p>The command to read/write into IC(EEPROM/ uCOM or DSP mycon) on camera.</p> <p>In the case of writing, since maximum number of addresses can be written at once is 32 addresses, data must be written 8 times separately if 256 bytes data must be written.</p> <p>[SLV]: Slave Address(Please refer to the Slave address for the ICs (8 bits) list) [START_H] x 16 + [START_L]: Star Address(0000~03FF) [END_H] x 16 + [END_L]: End Address(0000~03FF) [DATA (i)]: Data on Address i [DataLenH]: Upper Byte of [END_H]x16+[END_L]-[START_H]x16+[START_L]+6 [DataLenL]: Lower Byte of [END_H]x16+[END_L]-[START_H]x16+[START_L]+6</p> <p>●The format for reading data to the camera IC's is as follows:</p> <ul style="list-style-type: none"> • Send data 02, 4A, 00, 05, [SLV], [START_H], [START_L], [END_H], [END_L], [CHK], 03 Lower 8Bit of [CHK]=4A+00+05+[SLV]+[START_H]+[START_L]+[END_H]+[END_L] • Receive Data 02, 4A, [DataLenH], [DataLenL], [SLV], [START_H], [START_L], [END_H], [END_L], [DATASTART], [DATASTART+1],..., [DATAEND],[CHK],03 Lower 8Bit of [CHK]=4A+[DataLenH]+[DataLenL]+[SLV]+[START_H]+[START_L]+[END_H]+[END_L]+[DATASTART][DATASTART+1]+...+[DATAEND] <p>*An example of sending a command to read out all data (address 0000 to 07FF) from the IC (IC slave address is 50) is as follows: (02, 4A, 00, 03, 50, 00, 00, 07, FF, A3, 03)</p>

Command (HEX)	Command details
4A	<p>●The format for writing data to the camera IC's is as follows:</p> <ul style="list-style-type: none"> • Send Data 02, 4A, [DataLenH]+80, [DataLenL], [SLV], [START_H], [START_L], [END_H], [END_L], [DATASTART], [DATASTART1], ..., [DATAEND],[CHK],03 Lower 8bit of [CHK]=4A+([DataLenH]+80)+[DataLenL]+[SLV]+[START_H]+[START_L]+[END_H]+[END_L]+[DATASTART][DATASTART+1]+...+[DATAEND] • Receive Data 02, 4A, [DataLenH], [DataLenL], [SLV], [START_H], [START_L], [END_H], [END_L], [DATASTART], [DATASTART+1], ..., [DATAEND], [CHK], 03 Lower 8bit of [CHK]=4A+[DataLenH]+[DataLenL]+[SLV]+[START_H]+[START_L]+[END_H]+[END_L]+[DATASTART][DATASTART+1]+...+[DATAEND] <p>*An example of the sending data to write 23 to address 10 of the IC (IC slave address is 20) is as follows: (02, 4A, 80, 06, 20, 00, 10, 00, 10, 23, 33, 03)</p>
50	<p>This command is for sending an OSCD (On Screen Character Display) command to the camera. As stated above, when writing OSCD commands to the camera, 32 bytes is the maximum amount of data that can be written to the camera, with one communication. For additional information, please check section "OSCD Command". In order to generate an OSCD, set the "Command" to a value of 50. Set OSCD command to Data, set the number of byte of the OSCD command to Data Length.</p> <p>1. The format for sending a command to the camera to clear the display and then to generate a display of [0123] on the 3rd row of the 1st column is as follows: (02, 50, 80, 0A, 08, 92, 18, 38, DC, 10, 11, 12, 13, FF, E5, 03)</p>

5.3.2 Slave Address for the ICS (8bit) list

IC	Slave Address	Description
DSP	80	DSP
EEPROM	60	The Virtual EEPROM zone for the currently selected DSP preset mode of Preset0 to Preset7
EEPROM	90	The EEPROM zone for the Preset0 DSP data
EEPROM	91	The EEPROM zone for the Preset1 DSP data
EEPROM	92	The EEPROM zone for the Preset2 DSP data
EEPROM	93	The EEPROM zone for the Preset3 DSP data
EEPROM	94	The EEPROM zone for the Preset4 DSP data
EEPROM	95	The EEPROM zone for the Preset5 DSP data
EEPROM	96	The EEPROM zone for the Preset6 DSP data
EEPROM	97	The EEPROM zone for the Preset7 DSP data
uCOM	20	The uCOM data
EEPROM	40	The EEPROM zone for uCOM Data

*Note: The maximum numbers of times the EEPROM can be wrote to is 1,000,000.

5.3.3 Error Code List

If an error occurs, the camera will send out an error code with the following format:
The command number of the error message is FF (Hex). The data length is 0002.

Error	Receiving data
Check sum does NOT match the data being transmitted	02, FF, 00, 02, 03, 00, 04, 03
The command being transmitted does NOT exist or is invalid	02, FF, 00, 02, 04, 00, 05, 03
Unprocessed data remains in the receiving buffer	02, FF, 00, 02, 05, 00, 06, 03
Time out	02, FF, 00, 02, 06, 00, 07, 03
Over run error	02, FF, 00, 02, 08, 00, 09, 03
Framing error	02, FF, 00, 02, 09, 00, 0A, 03
Data length error (too long)	02, FF, 00, 02, 0B, 00, 0C, 03
I2C communication error	02, FF, 00, 02, 10, 00, 11, 03

*Note1: The camera disregard the data, which is not start with SOF.

*Note2: The time out error is occurred when does not receive the next data 3 seconds after receive the data.

5.4 The uCOM Register Mapping List

Please do not write the Reserved Address on this register map.

Address	7	6	5	4	3	2	1	0	Description	Default
000						X	X	X	User Preset DSP register setting can save on eight Preset area. *When this vale save to the EEPRM, the camera start with saved DSP mode at power u 0: Preset0 1: Preset1 2: Preset2 3: Preset3 4: Preset4 5: Preset5 6: Preset6 7: Preset7	0
	X	X	X	X	X				Reserved	
001 - 00D	X	X	X	X	X	X	X	X	Reserved	
00E								X	Control by the "Push button" on the side of the camera 0: Disable 1: Enable	1
	X	X	X	X	X	X	X		Reserved	
00F							X	X	UART baud rate 0: 9,600 bps 1: 19,200 bps 2: 38,400 bps 3: 9,600 bps * Change to the lower baud rate when the communication error is occurred.	2
			X	X	X	X			Reserved	
		X							Return data and data length of UART write command 0: Return data is including exact same data of write command. 1: Return data is excluding data of write command, and data length is 0.	0
	X								UART check sum 0: Disable 1: Enable * When select disable, the camera process command even check sum of send command is not mach.	1

Address	7	6	5	4	3	2	1	0	Description	Default
010	X	X	X	X	X	X	X	X	User defined color 0 Red	255
011	X	X	X	X	X	X	X	X	User defined color 0 Green	128
012	X	X	X	X	X	X	X	X	User defined color 0 Blue	0
013	X	X	X	X	X	X	X	X	User defined color 1 Red	255
014	X	X	X	X	X	X	X	X	User defined color 1 Green	0
015	X	X	X	X	X	X	X	X	User defined color 1 Blue	128
016	X	X	X	X	X	X	X	X	User defined color 2 Red	128
017	X	X	X	X	X	X	X	X	User defined color 2 Green	255
018	X	X	X	X	X	X	X	X	User defined color 2 Blue	0
019	X	X	X	X	X	X	X	X	User defined color 3 Red	0
01A	X	X	X	X	X	X	X	X	User defined color 3 Green	255
01B	X	X	X	X	X	X	X	X	User defined color 3 Blue	128
01C	X	X	X	X	X	X	X	X	User defined color 4 Red	128
01D	X	X	X	X	X	X	X	X	User defined color 4 Green	0
01E	X	X	X	X	X	X	X	X	User defined color 4 Blue	255
01F	X	X	X	X	X	X	X	X	User defined color 5 Red	0
020	X	X	X	X	X	X	X	X	User defined color 5 Green	128
021	X	X	X	X	X	X	X	X	User defined color 5 Blue	255
022	X	X	X	X	X	X	X	X	User defined color 6 Red	128
023	X	X	X	X	X	X	X	X	User defined color 6 Green	128
024	X	X	X	X	X	X	X	X	User defined color 6 Blue	128
025	X	X	X	X	X	X	X	X	User defined color 7 Red	255
026	X	X	X	X	X	X	X	X	User defined color 7 Green	207
027	X	X	X	X	X	X	X	X	User defined color 7 Blue	0
028					X	X	X	X	Control button (Decrease page) for display menu 9: WB 10: A 11: B 12: C 13: D 14: E 15: F	0
	X	X	X	X					Control button (Increase page) for display menu 9: WB 10: A 11: B 12: C 13: D 14: E 15: F	9
029					X	X	X	X	Menu: down Selectable Parameters are same as Address 028	15
	X	X	X	X					Menu: up Selectable Parameters are same as Address 028	11
02A					X	X	X	X	Menu: right Selectable Parameters are same as Address 028	14
	X	X	X	X					Menu: left Selectable Parameters are same as Address 028	12
02B					X	X	X	X	Menu: turn off Selectable Parameters are same as Address 028	10
	X	X	X	X					Menu: enter Selectable Parameters are same as Address 028	13
02C - 02F	X	X	X	X	X	X	X	X	Reserved	

Address	7	6	5	4	3	2	1	0	Description	Default
030 - 038	X	X	X	X	X	X	X	X	Reserved	
039	X	X	X	X	X	X	X	X	Primary switch function: single push * As for the detail of selectable function, please refer to the Push button function list	2
03A	X	X	X	X	X	X	X	X	External switch A function: single push * As for the detail of selectable function, please refer to the Push button function list	1
03B	X	X	X	X	X	X	X	X	External switch B function: single push * As for the detail of selectable function, please refer to the Push button function list	0
03C	X	X	X	X	X	X	X	X	External switch C function: single push * As for the detail of selectable function, please refer to the Push button function list	0
03D	X	X	X	X	X	X	X	X	External switch D function: single push * As for the detail of selectable function, please refer to the Push button function list	0
03E	X	X	X	X	X	X	X	X	External switch E function: single push * As for the detail of selectable function, please refer to the Push button function list	0
03F	X	X	X	X	X	X	X	X	External switch F function: single push * As for the detail of selectable function, please refer to the Push button function list	0
040 - 048	X	X	X	X	X	X	X	X	Reserved	
049	X	X	X	X	X	X	X	X	Primary switch function: hold * As for the detail of selectable function, please refer to the Push button function list	3
04A	X	X	X	X	X	X	X	X	External switch A function: hold * As for the detail of selectable function, please refer to the Push button function list	0
04B	X	X	X	X	X	X	X	X	External switch B function: hold * As for the detail of selectable function, please refer to the Push button function list	0
04C	X	X	X	X	X	X	X	X	External switch C function: hold * As for the detail of selectable function, please refer to the Push button function list	0
04D	X	X	X	X	X	X	X	X	External switch D function: hold * As for the detail of selectable function, please refer to the Push button function list	0
04E	X	X	X	X	X	X	X	X	External switch E function: hold * As for the detail of selectable function, please refer to the Push button function list	0
04F	X	X	X	X	X	X	X	X	External switch F function: hold * As for the detail of selectable function, please refer to the Push button function list	0
050							X	X	OSD menu color 0: Black 1: Blue 2: Green 3: Cyan 4: Red 5: Magenta 6: Yellow 7: White	7
					X				OSD character size 0: Large 1: Small	0
	X	X	X	X					Reserved	
051	X	X	X	X	X	X	X	X	OSD horizontal position 0: Left to 255:Right	0
052	X	X	X	X	X	X	X	X	OSD vertical position 0: Top to 255:Bottom	0
053 - 054	X	X	X	X	X	X	X	X	Reserved	

Address	7	6	5	4	3	2	1	0	Description	Default
055								X	Still Image 0: Disable 1: Enable	0
						X	X		Test Pattern selection 0: Off 2: Color Bar 1: Gray Scale 3: Color Bar + Gray Scale	0
	X	X	X	X	X				Reserved	
056		X	X	X	X	X	X	X	Digital Zoom M: Magnification , x : Setting Parameter $M = 128 / (128 - x)$	0
	X								Reserved	
057	X	X	X	X	X	X	X	X	Reserved	
058	X	X	X	X	X	X	X	X	Digital zoom pan(Horizontal Offset) [little-endian]	0
059						X	X	X	Two's complement	
	X	X	X	X	X				Reserved	
05A	X	X	X	X	X	X	X	X	Digital zoom tilt(Vertical Offset) [little-endian]	0
05B						X	X	X	Two's complement	
	X	X	X	X	X				Reserved	
05C	X	X	X	X	X	X	X	X	Horizontal line min position [little-endian](to Push Button)	0
05D	0	0	0	0	0	X	X	X		
05E	X	X	X	X	X	X	X	X	Horizontal line max position [little-endian](to Push Button)	1920
05F	0	0	0	0	0	X	X	X		
060	X	X	X	X	X	X	X	X	Horizontal line max thickness [little-endian](to Push Button)	1920
061	0	0	0	0	0	X	X	X		
062	X	X	X	X	X	X	X	X	Vertical line min position [little-endian](to Push Button)	0
063	0	0	0	0	0	X	X	X		
064	X	X	X	X	X	X	X	X	Vertical line max position [little-endian](to Push Button)	1080
065	0	0	0	0	0	X	X	X		
066	X	X	X	X	X	X	X	X	Vertical line max thickness [little-endian](to Push Button)	1080
067	0	0	0	0	0	X	X	X		
068	X	X	X	X	X	X	X	X	Shadow Horizontal Min position [little-endian](for Push Button)	0
069	0	0	0	0	0	X	X	X		
06A	X	X	X	X	X	X	X	X	Shadow Horizontal Max position [little-endian](for Push Button)	1920
06B	0	0	0	0	0	X	X	X		
06C	X	X	X	X	X	X	X	X	Shadow Vertical Min position [little-endian](for Push Button)	0
06D	0	0	0	0	0	X	X	X		
06E	X	X	X	X	X	X	X	X	Shadow Vertical Max position [little-endian](for Push Button)	1080
06F	0	0	0	0	0	X	X	X		
070 - 3FF	X	X	X	X	X	X	X	X	Reserved	

5.4.1 Push Button Function Menu

When the menu is displayed, the following functions are assigned for each Push Button.

WB: Increase Page	Increase Page Number
SW A: Return	Close the Menu
SW B: Increment	Increment cursor or value cursor or value
SW C: Select Left	Select Left Selection
SW D: execute	Execute the selected function
SW E: Select Right	Select Right Selection
SW F: Decrement	Decrement cursor or value

5.4.2 Push Button Function List

Value	Function	Function Description
0x00	Disabled	Disable Push button control
0x01	Display Menu	Display Menu on the screen
0x02	Push Lock WB [Save]	Execute Push Lock White Balance. And save the setting as AWB HOLD on the EEPROM
0x03	WB mode(AWB) [Save]	Set White Balance Mode: Auto, and save the setting on EEPROM
0x04	Change H Inversion	Horizontal flip the image
0x05	Change V Inversion	Vertical flip the image
0x06	Change HV Inversion	Horizontal-Vertical flip the image
0x07	Change H Inversion [Save]	Save the setting after H flip the image
0x08	Change V Inversion [Save]	Save the setting after V flip the image
0x09	Change HV Inversion [Save]	Save the setting after H-V flip the image
0x0A	Change display marker	Set the marker display enable or disable
0x0B	Change display line	Set the line display enable or disable
0x0C	Change display shadow	Set the shadow mask display enable or disable
0x0D	Change display marker [Save]	Set the marker display enable or disable, and save the setting on EEPROM
0x0E	Change display line [Save]	Set the line display enable or disable, and save the setting on EEPROM
0x0F	Change display shadow [Save]	Set the shadow mask display enable or disable, and save the setting on EEPROM
0x10	H Line Maker1 position (+)	Horizontal Line Marker1 shift to the bottom.
0x11	H Line Maker1 position (-)	Horizontal Line Marker1 shift to the top.
0x12	V Line Maker1 position (+)	Vertical Line Marker1 shift to the left.
0x13	V Line Maker1 position (-)	Vertical Line Marker1 shift to the right.
0x14	H Line Maker2 position (+)	Horizontal Line Marker2 shift to the bottom.
0x15	H Line Maker2 position (-)	Horizontal Line Marker2 shift to the top.
0x16	V Line Maker2 position (+)	Vertical Line Marker2 shift to the left.
0x17	V Line Maker2 position (-)	Vertical Line Marker2 shift to the right.
0x18	Shadow mask Top (+)	Shadow mask on top shift to the bottom.
0x19	Shadow mask Top (-)	Shadow mask on top shift to the top.
0x1A	Shadow mask Bottom (+)	Shadow mask on bottom shift to the bottom.
0x1B	Shadow mask Bottom (-)	Shadow mask on bottom shift to the top.
0x1C	Shadow mask Left (+)	Shadow mask on left shift to the right.
0x1D	Shadow mask Left (-)	Shadow mask on left shift to the left.
0x1E	Shadow mask Right (+)	Shadow mask on right shift to the right.
0x1F	Shadow mask Right (-)	Shadow mask on right shift to the left.

5.5 The DSP Register Mapping List

Address	7	6	5	4	3	2	1	0	Description	Default
000							X	X	AE mode 0: Normal AE 2: USER mode	0
	X	X	X	X	X	X			Reserved	
001	X	X	X	X	X	X	X	X	Normal AE maximum shutter time [little-endian]	400
002	X	X	X	X	X	X	X	X	1 step 0.1ms 1(100us) to 400(40ms)	
003	X	X	X	X	X	X	X	X	Reserved	
004	X	X	X	X	X	X	X	X	Normal AE maximum gain [little-endian]	140
005	X	X	X	X	X	X	X	X	1 step 0.3(dB) 4(1.2dB) to 150(45.0dB)	
006	X	X	X	X	X	X	X	X	Long AE normal shutter time [little-endian]	166
007	X	X	X	X	X	X	X	X	1 to 500(1step 0.1ms),501 to 1000(1step 1ms),1000 to 1200(1step 10ms)	
008	X	X	X	X	X	X	X	X	Long AE expanded shutter time [little-endian]	333
009	X	X	X	X	X	X	X	X	1 to 500(1step 0.1ms),501 to 1000(1 step 1ms),1000 to 1200(1 step 10ms)	
00A	X	X	X	X	X	X	X	X	Long AE maximum shutter time [little-endian]	600
00B	X	X	X	X	X	X	X	X	1 to 500(1step 0.1ms),501 to 1000(1 step 1ms),1000 to 1200(1 step 10ms)	
00C	X	X	X	X	X	X	X	X	Long AE low gain [little-endian]	96
00D	X	X	X	X	X	X	X	X	1 step 0.3(dB) 4(1.2dB) to 150(45.0dB)	
00E	X	X	X	X	X	X	X	X	Long AE high gain [little-endian]	120
00F	X	X	X	X	X	X	X	X	1 step 0.3(dB) 4(1.2dB) to 150(45.0dB)	
010	X	X	X	X	X	X	X	X	Long AE maximum gain [little-endian]	140
011	X	X	X	X	X	X	X	X	1 step 0.3(dB) 4(1.2dB) to 150(45.0dB)	
012	X	X	X	X	X	X	X	X	USER mode shutter time [little-endian]	100
									Shutter time on USER mode(Manual)	
013	X	X	X	X	X	X	X	X	When USER mode is selected on AE mode. This register is available. 1 to 500(1step 0.1ms),501 to 1000(1step 1ms),1000 to 1200(1step 10ms)	
014	X	X	X	X	X	X	X	X	USER mode gain [little-endian]	0
									Gain on USER mode(Manual)	
015	X	X	X	X	X	X	X	X	When USER mode is selected on AE mode. This register is available. Value x 0.3 + 1.2 [dB]	
016 - 019	X	X	X	X	X	X	X	X	Reserved	
01A							X	X	Flickerless mode 0: Auto 4: 60Hz fixed Please don't access to rest of value	5
	X	X	X	X	X				Reserved	
01B	X	X	X	X	X	X	X	X	AE convergence speed Set the convergence speed Max : 10、When larger number set, AE works slower.	32
01C	X	X	X	X	X	X	X	X	Convergence end dead band range	26
01D	X	X	X	X	X	X	X	X	Frame count for outside the dead band	8
01E	X	X	X	X	X	X	X	X	AE tracking start dead band range	4
01F	X	X	X	X	X	X	X	X	Reserved	

Normal AE

When AE Mode = 0[h] was selected, the normal AE mode is established. The gain and exposure time are automatically adjusted so that the images have the appropriate brightness.

Maximum Exposure time can be set on Normal AE maximum shutter time (0x001-0x002).
Maximum Gain can be set on Normal AE maximum gain (0x004-0x005).

In the normal mode, it is not possible to extend the exposure time beyond the frame rate. This level is referred to as the maximum exposure time. To extend the exposure time beyond the frame rate, please select Long AE.

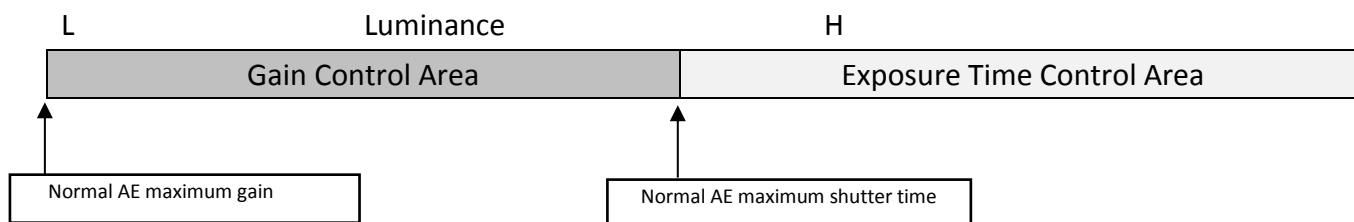

Long AE

When the AE mode = 1[h] is selected, the long AE control mode is established. Long AE control makes it possible to expand the frame rate and obtain a longer exposure time. The the long AE can keep the best image in low luminance.

Exposure time control on normal area can be set on Long AE normal shutter time (0x006-0x007).
Gain control on normal area can be on Long AE low gain (0x00C-0x00D).
Exposure time control on expanded area can be set on Long AE expanded shutter time (0x008-0x009).
Gain control on expanded area can be set on Long AE expanded shutter time (0x00E-0x00F).
Exposure time control on maximum area can be set on Long AE maximum shutter time (0x00A-0x00B).
Gain control on maximum area can be set on Long AE maximum gain (0x010-0x011).

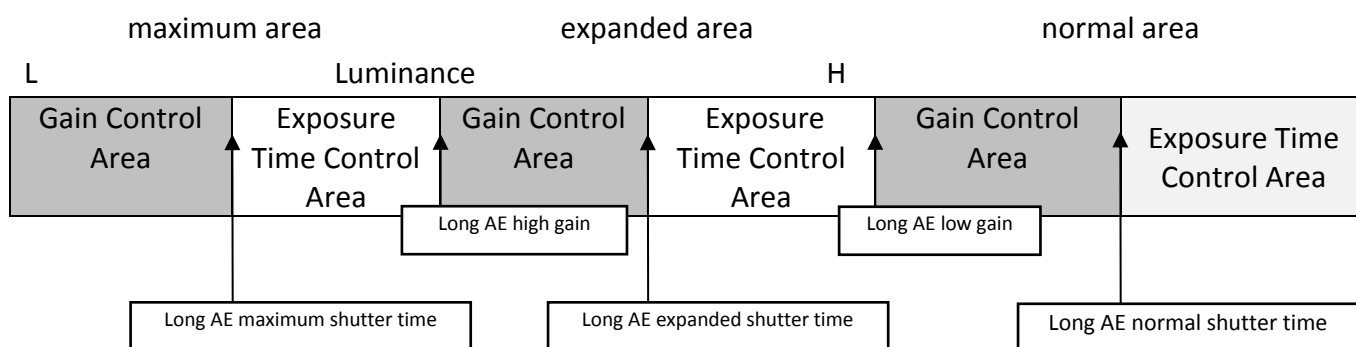

Please use the rule below:

Long AE normal shutter time \leq Long AE expanded shutter time \leq Long AE maximum shutter time
Long AE low gain \leq Long AE high gain \leq Long AE maximum gain

USER mode

When AE mode = 2[h] was selected, the USER mode is established. In this USER mode, the gain and exposure time can be configured. If exposure time is longer than Normal AE maximum shutter time, Long AE mode will be available.

Exposure time can be on USER mode shutter time (0x012-0x013).

Gain can be set on USER mode gain (0x014-0x015).

Flicker-less Mode

Horizontal band noise that is called “rolling bars” or “Flicker” is generated when shooting under fluorescent lights whose flickering periods differ from the shutter periods. This function is able to reduce the rolling bars by adjusting the shutter speed so as to match the light-emitting frequency of the fluorescent lights.

Auto Flicker-less

If 50Hz flicker is detected, it will shift to 50Hz flicker-less. If 60Hz flicker is detected, it will shift to 60Hz flicker-less. When judging with outdoor light during flicker-less compensation, flicker-less compensation shifts to OFF state.

50/60HZ fixed Flicker-less mode

The table below shows the exposure times when the frame rate is 25, 30, 50, 60 and when the 50Hz mode and 60Hz mode are established by selecting this mode, respectively, as the flicker-less mode setting. The exposure time changes in steps. The minimum shutter time is approx. 1/100s and 1/120s in the 50Hz mode and 60Hz mode, respectively. This minimum shutter time is called the flicker-less minimum fixed shutter time and the maximum is called flicker-less maximum shutter time.

Frame Rate 25fps				Frame Rate 30fps			
50Hz Fixed mode		60Hz Fixed mode		50Hz Fixed mode		60Hz Fixed mode	
39.8ms	1/25	33.4ms	1/29	—	—	33.2ms	1/30
20.1ms	1/49	16.6ms	1/60	20.1ms	1/49	16.6ms	1/60
10ms	1/100	8.3ms	1/120	10ms	1/100	8.3ms	1/120

Frame Rate 50fps				Frame Rate 60fps			
50Hz Fixed mode		60Hz Fixed mode		50Hz Fixed mode		60Hz Fixed mode	
20.1ms	1/49	16.6ms	1/60	—	—	16.6ms	1/60
10ms	1/100	8.3ms	1/120	10ms	1/100	8.3ms	1/120

AE convergent speed

The AE convergence speed register is used to set the time to be taken for the exposure amount appropriate for the image to be established. The fastest setting is A[h]. If the setting is too high, the AE convergence speed will be reduced. Conversely if it is too low, hunting may occur.

Convergence end dead band range

The Convergence end identification dead band range register is used to set the range in which convergence is to be identified, and convergence end is identified when the absolute value of the error amount is below the setting and the same status has continued for 3 frames. The dead band range is the setting x 6.02/1024 [dB].

Frame count for outside the dead band

This function is used to ensure that the AE operation will not overly respond to changes in the subject when an object has pass across the shooting screen while AE is in the appropriate status. Tracking is started when the AE error amount is above the setting and has continued for at least the number of Frame count for outside the dead band frames.

The dead band range is the setting x 16 x 6.02/1024 [dB]

Address	7	6	5	4	3	2	1	0	Description	Default
020	X	X	X	X	X	X	X	X	Convergence luminance [little-endian]	4608
021	X	X	X	X	X	X	X	X	This setting is target luminance at which AE has converged to the appropriate luminance	
022 - 027	X	X	X	X	X	X	X	X	Reserved	
028	X	X	X	X	X	X	X	X	Gain Priority Mode 0: Disable 5: 1.20[dB] 6: 3.31[dB] 7: 5.12[dB] 8: 6.92[dB] 9: 9.33[dB] 10: 11.14[dB] 11: 12.94[dB] 12: 15.34[dB] 13: 17.16[dB] 14: 18.96[dB] 15: 21.37[dB] 16: 23.18[dB] 17: 24.00[dB] 18: 27.09[dB] 19: 29.20[dB] Please don't select rest of 1, 2, 3, 4, 20.	0
029	X	X	X	X	X	X	X	X	Shutter Priority Mode [little-endian] 0: Disable	0
02A	X	X	X	X	X	X	X	X	1 to 500(1Step 0.1msec),501 to 1000(1Step 1msec),1000 to 1200(1Step 10msec)	
02B - 02F	X	X	X	X	X	X	X	X	Reserved	

Gain Priority Mode

Gain Priority (0x28) involves adjusting the shutter time automatically so that image is set to the optimum brightness after the gain level is fixed. Set the AE mode register to normal AE=0[h] or long AE =1[h]. When any value except =0[h] is set on the Gain Priority (0x28) register, the mode is gain priority. When the value is 0[h], the mode is removed.

Shutter Priority Mode

Shutter Priority (0x29-0x2A) functions to automatically adjust the gain with the shutter time fixed to achieve the appropriate images. Set the AE mode register to normal AE=0[h] or Long AE = 1[h]. When =0[h] is set, shutter priority is set to off, and the normal AE mode is established.

Address	7	6	5	4	3	2	1	0	Description	Default
030							X	X	White Balance Mode 0: Auto 1: Full Open 2: AWB Hold 3: USER Mode	0
		X	X	X	X	X			Reserved	
	X								Push Lock(After the Push Lock, White Balance mode turn to the AWB mode automatically) 0: OFF 1: ON (Automatically turn 0, after convergence)	0
031	X	X	X	X	X	X	X	X	AWB Pull-in Delay Unit: Frame number When a status outside the dead band has been detected in the ATW mode, pull-in is started after achieving consistency in the number of frames specified by the this register.	8
032	X	X	X	X	X	X	X	X	AWB Pull-in Speed Unit: Frame number Pull-in speed of ATW mode is set in the number of frames specified by the this register. This register is available in Auto, or Full Open on White Balance Mode	1
033	X	X	X	X	X	X	X	X	Convergence Step inside target area The ATW pull-in steps inside target area can be indicated. When set step shortly, the convergence speed of white balance is faster.	12
034	X	X	X	X	X	X	X	X	Convergence Step outside target area The ATW pull-in steps outside target area can be indicated. When set step shortly, the convergence speed of white balance is faster.	12
035	X	X	X	X	X	X	X	X	Pull-in Step for Full Open When set the number of steps for full open mode pull-in, the convergence speed is faster.	2
036	X	X	X	X	X	X	X	X	User Mode fixed coordinate R/G	2453
037	X	X	X	X	X	X	X	X	This register is available on USER mode	
038	X	X	X	X	X	X	X	X	User Mode fixed coordinate B/G	7295
039	X	X	X	X	X	X	X	X	This register is available on USER mode	
03A - 03F	X	X	X	X	X	X	X	X	Reserved	
040	0	0	0	0	X	X	X	X	Resolution/FrameRate 0: 1080p 60fps 1: 1080p 30fps 3: 1080p 50fps 4: 1080p 25fps 6: 720p 60fps 7: 720p 50fps 10: 1080p 59.94fps 11: 1080p 29.97fps 13: 720p 59.94fps	0
041							X	X	Image Output Inversion 0: Standard 1: H Inversion 2: V Inversion 3: HV Inversion	0
	X	X	X	X	X	X			Reserved	
042	X	X	X	X	X	X	X	X	Reserved	

White Balance

- **Auto (auto Trace White Balance)**
AWB Pull-In-Speed, AWB Pull-In Delay, Convergence Step can be configurable. This function sets the pull-in frame and target frame and automatically tracks the changes in the color temperature to adjust the white balance.
- **Full-Open**
This function adjusts the white balance regardless of the subject conditions. The control is exercised at all times without depending on the pull-in frame.
- **AWB Hold**
When the hold mode is established, the white balance (WB) gain value established at that time is held, and the AWB operation is stopped.
- **Push Lock Function**
When the White Balance Mode is set to “2” (Full Open), and White Balance Mode is set to “AWB Hold”. The white balance gain values are kept and white balance is stopped. This function that saves the data in the EEPROM is called the Push Lock Function.

When AWB hold mode is established, the white balance gain values at this time are saved in the registers, and the white balance gain is held. When push the “Push Lock” button on the control software, the mode turns from Full-Open to AWB Hold Save the White Balance Mode = AWB Hold on EEPROM.
- **USER mode**
In the normal user mode, the white balance can be adjusted exactly as desired. To see the white balance through User Mode fixed coordinate R/G (0x036-0x037) and User Mode fixed coordinate B/G (0x38-0x39).

Address	7	6	5	4	3	2	1	0	Description	Default
043						X	X	X	Gamma Mode 0: Manual 1: 0.45 2: 0.6 3: 0.8 4: 1.0	0
				X	X				Gamma Output Selection 0: Converted Output 1: Unconverted Output	0
	X	X	X						Reserved	
044	X	X	X	X	X	X	X	X	Manual Gamma00 [little-endian]	408
045	0	0	0	0	X	X	X	X		
046	X	X	X	X	X	X	X	X	Manual Gamma01 [little-endian]	432
047	0	0	0	0	X	X	X	X		
048	X	X	X	X	X	X	X	X	Manual Gamma02 [little-endian]	464
049	0	0	0	0	X	X	X	X		
04A	X	X	X	X	X	X	X	X	Manual Gamma03 [little-endian]	496
04B	0	0	0	0	X	X	X	X		
04C	X	X	X	X	X	X	X	X	Manual Gamma04 [little-endian]	544
04D	0	0	0	0	X	X	X	X		
04E	X	X	X	X	X	X	X	X	Manual Gamma05 [little-endian]	592
04F	0	0	0	0	X	X	X	X		
050	X	X	X	X	X	X	X	X	Manual Gamma06 [little-endian]	640
051	0	0	0	0	X	X	X	X		
052	X	X	X	X	X	X	X	X	Manual Gamma07 [little-endian]	688
053	0	0	0	0	X	X	X	X		
054	X	X	X	X	X	X	X	X	Manual Gamma08 [little-endian]	736
055	0	0	0	0	X	X	X	X		
056	X	X	X	X	X	X	X	X	Manual Gamma09 [little-endian]	768
057	0	0	0	0	X	X	X	X		
058	X	X	X	X	X	X	X	X	Manual Gamma10 [little-endian]	0
059	0	0	0	0	X	X	X	X		
05A	X	X	X	X	X	X	X	X	Manual Gamma11 [little-endian]	636
05B	0	0	0	0	X	X	X	X		
05C	X	X	X	X	X	X	X	X	Manual Gamma12 [little-endian]	869
05D	0	0	0	0	X	X	X	X		
05E	X	X	X	X	X	X	X	X	Manual Gamma13 [little-endian]	992
05F	0	0	0	0	X	X	X	X		
060	X	X	X	X	X	X	X	X	Manual Gamma14 [little-endian]	1088
061	0	0	0	0	X	X	X	X		
062	X	X	X	X	X	X	X	X	Manual Gamma15 [little-endian]	1168
063	0	0	0	0	X	X	X	X		
064	X	X	X	X	X	X	X	X	Manual Gamma16 [little-endian]	1240
065	0	0	0	0	X	X	X	X		
066	X	X	X	X	X	X	X	X	Manual Gamma17 [little-endian]	1300
067	0	0	0	0	X	X	X	X		
068	X	X	X	X	X	X	X	X	Manual Gamma18 [little-endian]	1320
069	0	0	0	0	X	X	X	X		
06A	X	X	X	X	X	X	X	X	Manual Gamma19 [little-endian]	1332
06B	0	0	0	0	X	X	X	X		

Address	7	6	5	4	3	2	1	0	Description	Default
06C	X	X	X	X	X	X	X	X	Manual Gamma20 [little-endian]	1348
06D	0	0	0	0	X	X	X	X		
06E	X	X	X	X	X	X	X	X	Manual Gamma21 [little-endian]	1360
06F	0	0	0	0	X	X	X	X		
070	X	X	X	X	X	X	X	X	Manual Gamma22 [little-endian]	1372
071	0	0	0	0	X	X	X	X		
072	X	X	X	X	X	X	X	X	Manual Gamma23 [little-endian]	1388
073	0	0	0	0	X	X	X	X		
074	X	X	X	X	X	X	X	X	Manual Gamma24 [little-endian]	1404
075	0	0	0	0	X	X	X	X		
076	X	X	X	X	X	X	X	X	Manual Gamma25 [little-endian]	1420
077	0	0	0	0	X	X	X	X		
078	X	X	X	X	X	X	X	X	Manual Gamma26 [little-endian]	1436
079	0	0	0	0	X	X	X	X		
07A	X	X	X	X	X	X	X	X	Manual Gamma27 [little-endian]	1452
07B	0	0	0	0	X	X	X	X		
07C	X	X	X	X	X	X	X	X	Hue Adjustment (Two's complement)	0
07D	X	X	X	X	X	X	X	X	Saturation Adjustment	128
07E	X	X	X	X	X	X	X	X	Sharpness Gain	64
07F								X	ATR-EX(HDR) 0: OFF 1: ON	0
	X	X	X	X	X	X	X			
080								X	Photometry Mode 0: Average Photometry 1: Weight Photometry	0
	X	X	X	X	X	X	X			
081	X	X	X	X	X	X	X	X	0frame coefficient (on Weight Photometry)	9
082	X	X	X	X	X	X	X	X	1frame coefficient (on Weight Photometry)	15
083	X	X	X	X	X	X	X	X	2frame coefficient (on Weight Photometry)	9
084	X	X	X	X	X	X	X	X	3frame coefficient (on Weight Photometry)	18
085	X	X	X	X	X	X	X	X	4frame coefficient (on Weight Photometry)	72
086	X	X	X	X	X	X	X	X	5frame coefficient (on Weight Photometry)	18
087	X	X	X	X	X	X	X	X	6frame coefficient (on Weight Photometry)	12
088	X	X	X	X	X	X	X	X	7frame coefficient (on Weight Photometry)	30
089	X	X	X	X	X	X	X	X	8frame coefficient (on Weight Photometry)	12
08A - OFF	X	X	X	X	X	X	X	X	Reserved	

- **Gamma Mode**
When use preset value, 1: 0.45, 2: 0.6, 3: 0.8, 4: 1.0 on Gamma Mode can be selected. When using Manual. 0: Manual should be selected and set the Gamma KNOT00 to 27.
- **Photometry Mode**
In order to achieve the optimum luminance, the photometry mode of this DSP either automatically adjusts the gain value and exposure time to achieve the optimum luminance level by detecting the luminance signals in the screen region using 9 frames (3 horizontal x 3 vertical frames) and giving weighting to this region on the screen.

Average Photometry ●●● This evaluation mode uses the same weighting for all 9 frames.

Weight Photometry ●●●● The weighting for each of the 9 frames can be specified.

Address	7	6	5	4	3	2	1	0	Description	Default
100								X	Line Marker 0: Disable 1: Enable	1
							X		Shadow Mask 0: Disable 1: Enable	1
						X			Reserved	
	X		X	X	X	X			Reserved	
101	X	X	X	X	X	X	X	X	Shadow mask shading level 0: Invisible 255: Black	0
102	X	X	X	X	X	X	X	X	Horizontal shadow mask top position [little-endian]	0
103	0	0	0	0	0	X	X	X	0: Top 1080: Bottom	
104	X	X	X	X	X	X	X	X	Horizontal shadow mask bottom position [little-endian]	1080
105	0	0	0	0	0	X	X	X	0: Top 1080: Bottom	
106	X	X	X	X	X	X	X	X	Vertical shadow mask left position [little-endian]	0
107	0	0	0	0	0	X	X	X	0: Left 1920: Right	
108	X	X	X	X	X	X	X	X	Vertical shadow mask right position [little-endian]	1920
109	0	0	0	0	0	X	X	X	0: Left 1920: Right	
10A					X	X	X	X	Horizontal line1 marker color *as for the configurable color, please refer to the color code chart	0
	X	X	X	X					Vertical line1 marker color *as for the configurable color, please refer to the color code chart	0
10B	X	X	X	X	X	X	X	X	Horizontal line1 marker position [little-endian]	0
10C	0	0	0	0	0	0	0	X	0: Top 1080: Bottom	
10D	X	X	X	X	X	X	X	X	Horizontal line1 marker thickness [little-endian]	0
10E	0	0	0	0	0	0	0	X	0: Invisible 1080: Maximum	
10F	X	X	X	X	X	X	X	X	Vertical line1 marker position [little-endian]	0
110	0	0	0	0	0	0	0	X	0: Left 1920: Right	
111	X	X	X	X	X	X	X	X	Vertical line1 marker thickness [little-endian]	0
112	0	0	0	0	0	0	0	X	0: Invisible 1920: Maximum	
113					X	X	X	X	Horizontal line2 marker color *as for the configurable color, please refer to the color code chart	0
	X	X	X	X					Vertical line2 marker color *as for the configurable color, please refer to the color code chart	0
114	X	X	X	X	X	X	X	X	Horizontal line2 marker position [little-endian]	0
115	0	0	0	0	0	0	0	X	0: Top 1080: Bottom	
116	X	X	X	X	X	X	X	X	Horizontal line2 marker thickness [little-endian]	0
117	0	0	0	0	0	0	0	X	0: Invisible 1080: Maximum	

Address	7	6	5	4	3	2	1	0	Description	Default
118	X	X	X	X	X	X	X	X	Vertical line2 marker position [little-endian]	0
119	0	0	0	0	0	0	0	X	0: Left 1920: Right	
11A	X	X	X	X	X	X	X	X	Vertical line2 marker thickness [little-endian]	0
11B	0	0	0	0	0	0	0	X	0: Invisible 1920: Maximum	
11C - 124	X	X	X	X	X	X	X	X	Reserved	
125								X	Picture mode selection 0: Normal 1: Pseudo	0
							X		Normal color mode shadow mask line color 0: Black 1: Overlay graphics pseudo color	0
	X	X	X	X	X	X			Reserved	
126					X	X	X	X	Background pseudo color *as for the configurable color, please refer to the color code chart	1
	X	X	X	X					Overlay graphics pseudo color *as for the configurable color, please refer to the color code chart	0
127	X	X	X	X	X	X	X	X	Pseudo color threshold Set threshold value during Pseudo Color	48
128	X	X	X	X	X	X	X	X	Pseudo color slope Set the Pseudo Color slope $(=(value+8)/8)$ When the value is set to 0, the gradient will be maintained throughout and no Pseudo Color will occur. As the value increases, the gradient will increase until 255 when it becomes a Pseudo Color image with only two values. With large values, please be cautious of flickering at the boundary positions.	16
129	X	X	X	X	X	X	X	X	Contrast Set the output gain. Formula = (setting / 128)	128
12A		X	X	X	X	X	X	X	RGB offset	0
	X								Color / Monochrome 0: Color 1: Monochrome	0
12B					X	X	X	X	Aperture H. gain in back process	4
	X	X	X	X					Aperture V. gain in back process	6
12C	0	0	X	X	X	X	X	X	Aperture coring in back process	3
12D -	X	X	X	X	X	X	X	X	Reserved	

Color Code Table

16 defined colors can be selected from the following table and these can be reggered to via the Line Marker and Pseudo Color. As for the User Defined Color 0 to 7, the user can configure these color settings through serial communication.

Code	Color
0	Black
1	White
2	Red
3	Green
4	Blue
5	Cyan
6	Magenta
7	Yellow
8	User Defined Color 0
9	User Defined Color 1
10	User Defined Color 2
11	User Defined Color 3
12	User Defined Color 4
13	User Defined Color 5
14	User Defined Color 6
15	User Defined Color 7

5.6 OSD (On Screen Display) Command

5.6.1 2Byte Command

Note: The data has to be sent in the following order: D15-D8, D7-D0

Function	D15	D14	D13	D12	D11	D10	D9	D8	D7	D6	D5	D4	D3	D2	D1	D0
Video RAM Batch Clear Command	0	0	0	0	0	0	0	0	0	0	0	0	0	0	0	0
Display Control Command	0	0	0	0	1	0	0	0	DO	0	FC	FA	0	0	BL1	BL0
Character Size Control Command	0	0	0	1	0	0	V4	V3	V2	V1	V0	H4	H3	H2	H1	H0
Write Address Control Command	0	0	0	1	1	0	0	AD8	AD7	AD6	AD5	AD4	AD3	AD2	AD1	AD0
Character Size Control Command	0	0	1	0	0	0	SV1	SV0	SH1	SH0	0	0	AR3	AR2	AR1	AR0

Video RAM Batch Clear Command

Clear all the character data (12lines28Digits) on Video RAM. Meanwhile, Blinking, Frame Color and character size might set as default (00H) on all lines.

Display Control Command

DO: Display (0:Display ON, 1: Display OFF)
 FC: Frame Color (0:Black, 1:White)
 FA: Framing (0:ON, 1:OFF)
 BL1, BL0: Set the Blinking Frequency (00:Blinking OFF, 01: Blinking Frequency approximately 2Hz, 01: Blinking Frequency approximately 1Hz, 03: Blinking Frequency approximately 0.5Hz)

Character Size Control Command

Set the start position. 32 steps / 8 dots unit on horizontal. 32 steps/4 lines unit on vertical.
 H4, H3, H2, H1: 8 dots unit (0 to 31)
 V4, V3, V2, V1: 4 lines unit (0 to 31)

Write Address Control Comman

AD8, AD7, AD6, AD5, AD4, AD3, AD2, AD1, AD0 : Address (0 to 335)
 Set the address to write the character. the address consist of RAW 0 (Column 0 to 27), RAW 1 (Column 56 to 83)... RAW11 (Column 308 to 335).

Character Size Control Command

Set the character size for each RAW.
 SV1, SV0: Size on Vertical (00: x1, 01: x2, 02: x3, 03: x4)
 SH1, SH0: Size on Horizontal (00: x1, 01: x2, 02: x3, 03: x4)
 AR3, AR2, AR1, AR0: RAW (0 to 11)

5.6.2 2 Byte Consecutive Command

Note: The data has to be sent in the following order: D15-D8, D7-D0.

Function	D15	D14	D13	D12	D11	D10	D9	D8	D7	D6	D5	D4	D3	D2	D1	D0
Display Character Control Command	1	1	RV	R	G	B	BL	0	C7	C6	C5	C4	C3	C2	C1	C0

Display Character Control Command

Set the Writing character data, character color, blink data into Video RAM address.

This command is 2 Byte consecutive command, if more than 2 consecutive character writing are required, just send only lower 8bits (C7 to C0). Write address will be increased automatically.

When character control exits, please send 0xFF (End code of 2 Byte consecutive command).

RV : Character color reverse specification (0:OFF, 1:ON)

RGB : Character Color (0:Black, 1:Blue, 2:Green, 3:Cyan, 4:Red, 5:Magenta, 6:Yellow, 7:White)

BL : Character blinks (0:Blink, 1:Not Blink)

C7-C0 : Character code (please refer to the Character table as below)

C7-C0	Character	C7-C0	Character	C7-C0	Character
000	sp	021	A	042	b
001	!	022	B	043	c
002	"	023	C	044	d
003	#	024	D	045	e
004	\$	025	E	046	f
005	%	026	F	047	g
006	&	027	G	048	h
007	'	028	H	049	i
008	(029	I	04A	j
009)	02A	J	04B	k
00A	*	02B	K	04C	l
00B	+	02C	L	04D	m
00C	,	02D	M	04E	n
00D	-	02E	N	04F	o
00E	.	02F	O	050	p
00F	/	030	P	051	q
010	0	031	Q	052	r
011	1	032	R	053	s
012	2	033	S	054	t
013	3	034	T	055	u
014	4	035	U	056	v
015	5	036	V	057	w
016	6	037	W	058	x
017	7	038	X	059	y
018	8	039	Y	05A	z
019	9	03A	Z	05B	.
01A	:	03B	[05C	..
01B	;	03C	¥	05D	...
01C	<	03D]	05E	~
01D	=	03E	< fill	05F	◆
01E	>	03F	△	060	×
01F	?	040	▽	061	÷
020	> fill	041	a	0FF	2 byte char command finish

Rev	Date	Changes	Note
.05	March 14, 2014	Update to Latest Version	RM