

SENTECH

Remote Head Series Product Specifications



Features

- Various Connector Types
- Cased or Board Models
- Multiple Head Configurations
- 16 DIP Switches

Product Precautions

- **Handle the camera with care. Do not abuse the camera. Avoid striking or shaking it. Improper handling or storage could damage the camera.**
- **Do not pull or damage the camera cable.**
- **During camera use, do not wrap the unit in any material. This will cause the internal temperature of the unit to increase.**
- **Do not expose the camera to moisture, or do not try to operate it in wet areas.**
- **Do not operate the camera beyond its temperature, humidity and power source ratings.**
- **While the camera is not being used, keep the lens or lens cap on the camera to prevent dust or contamination from getting in the Sensor or filter area and scratching or damaging this area.**
- **Do not keep the camera under the following conditions:**
 - **In wet, moist, and high humidity areas**
 - **Under hot direct sunlight**
 - **In high temperature areas**
 - **Near an object that releases a strong magnetic or electric field**
 - **Areas with strong vibrations**
- **Apply the power that satisfies the requirements specified in this document to the camera.**
- **Use a soft cloth to clean the camera. Use pressured air spray to clean the surface of the glass. DO not scratch the surface of the glass.**
- **The camera is a general-purpose electronic device; using the camera for the equipment that may threaten human life or cause dangers to human bodies directly in case of failure or malfunction of the camera is not guaranteed. Use the camera for special purposes at your own risk.**

Table of Contents

1	NAMING METHOD	4
2	ELECTRONIC SPECIFICATIONS STC-R640, STC-R645	5
3	SPECTRAL SENSITIVITY CHARACTERISTICS	6
3.1	STC-R640 (ICX228AKB)	6
3.2	STC-R645 (ICX229AKB)	6
4	SWITCH SPECIFICATIONS	7
5	4 DESCRIPTION OF EACH BACK PANEL (STC-R640/645)	9
5.1	Case: PWT Model	9
5.2	Case: PWJ Model.....	10
5.3	Case: PWC Model	11
5.1	Board: P2,L2,CS2 Common Specification	12
6	LIST OF FIXED LENS	13
7	CABLE LENGTH	13
8	CCD REMOTE HEAD SHAPE	13
9	DIMENSIONS	14
9.1	CCD Remote Head	14
9.2	Cased(C-Mount): PWT, PWJ, PWC.....	15
9.3	Board	16
10	CAMERA SET UP.....	17
11	THE COMMUNICATION PROTOCOL SPECIFICATIONS AND CONTROL SOFTWARE MANUAL	17
11.1	Communication settings	17
11.2	Communication format	17
11.2.1	Specifications of the sent commands	17
11.2.2	Specifications of the received data	20
11.3	Camera Control Command and Software Manual	22
11.3.1	Port Driver Function	22
11.3.2	Shutter/Gain.....	23
11.3.3	Chroma	31
11.3.4	Gamma	34
11.3.5	BLC	37
11.3.6	White Balance.....	41
11.3.7	ME	42
11.3.8	Aperture	48
11.3.9	Other	50
12	REVISIONS.....	54

1 Naming Method

CCU

STC-R6xxx xxx

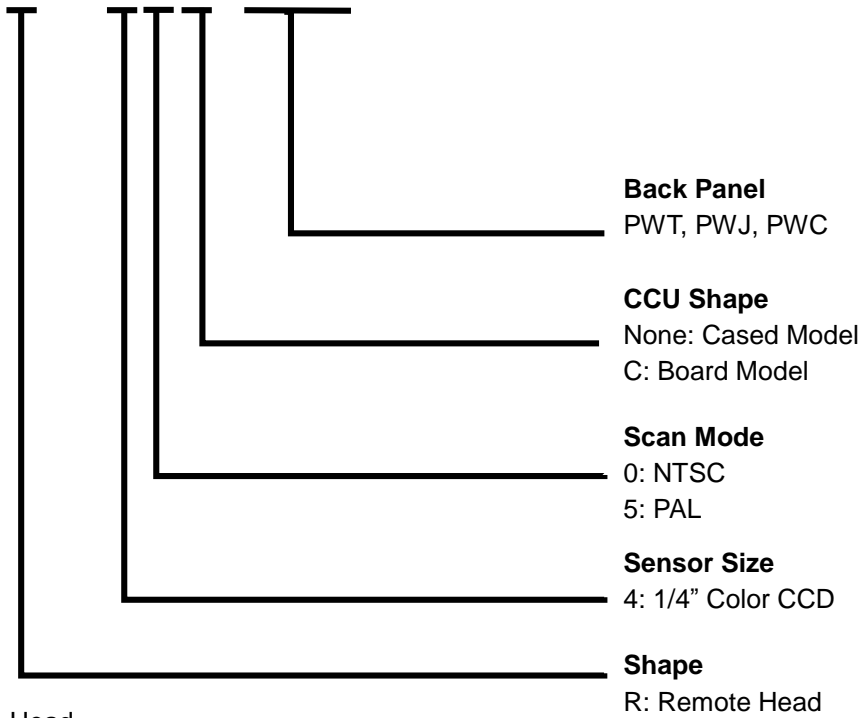

CCD Remote Head

STC-R6xx xxx x

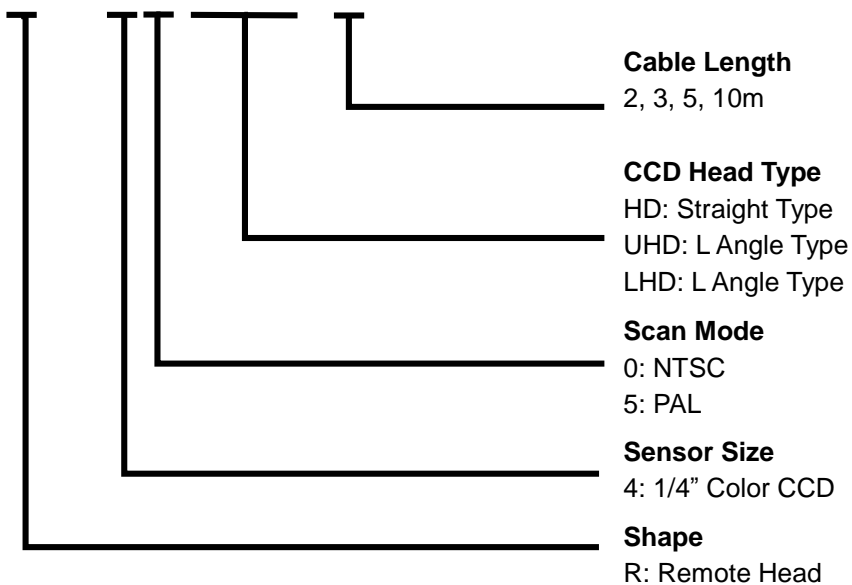

2 Electronic Specifications STC-R640, STC-R645

Model Number	STC-R640	STC-R645
Image Sensor	1/4 inch Interline CCD ICX228AKB	1/4 inch Interline CCD ICX229AKB
Active Picture Elements	768(H) x 494(V)	752 (H) x 582 (V)
Signal Format	NTSC	PAL
Scanning System	2:1Interlaced	
Scanning Frequency	Horizontal Frequency 15.734kHz Vertical Frequency 59.94Hz	Horizontal Frequency 15.625kHz Vertical Frequency 50.00Hz
Sync System	Internal / External: Cased Model, Internal: Board Model	
Horizontal Resolution	480 TV Lines	
S/N Ratio	> 48 dB (AGC=OFF)	
Video Output Format	VBS, Y/C(1.0Vp-p 75Ω)	
Minimum Scene illumination	1.1 lx, F1.2 (AGC=ON)	1.1 lx, F1.2 (AGC=ON)
Electronic Shutter	[Dip Switch] 1/60(1/50:PAL), 1/125, 1/250, 1/500, 1/1000, 1/2000, 1/4000, 1/10000 sec [Auto/Control Software] High Speed Shutter: 1/60(1/50:PAL) to 1/100000 sec Low Speed Shutter: 1 to 256FLD	
White Balance	Auto / Push to Set / Manual (default: Auto)	
AGC	ON / OFF (default: ON)	
Gamma	0.45/1.0 (Switchable, Configurable through the control software), Defalut:0.45	
Image Rotation	Normal (Default),Horizontal Flip, Vertical Flip, Horizontal Vertical Flip	
Still Image	Support	
CCD Head	Lens Mount	C Mount, Fixed lens
	Optical LPF	IR Cut Filter
	Cable Length	2,3,5,10m
Input Voltage	DC9V to 15V	
Power Consumption	95mA ± 20mA	
Operational Temperature	-10°C to +50°C	
Storage Temperature	-30°C to +60°C	
Dimensions	CCD Case: 51(W) x 51(W) x 55.5(D) mm CCU Board(C): 45(W) x 45(W) x 30(D) mm ※1	
Weight	CCD Case: Approximately 210 g CCU Board(C): Approximately TBD g	
Compliance	RoHS, REACH Compliance	

※1 Excluding back panel connector and components.

3 Spectral Sensitivity Characteristics

3.1 STC-R640 (ICX228AKB)

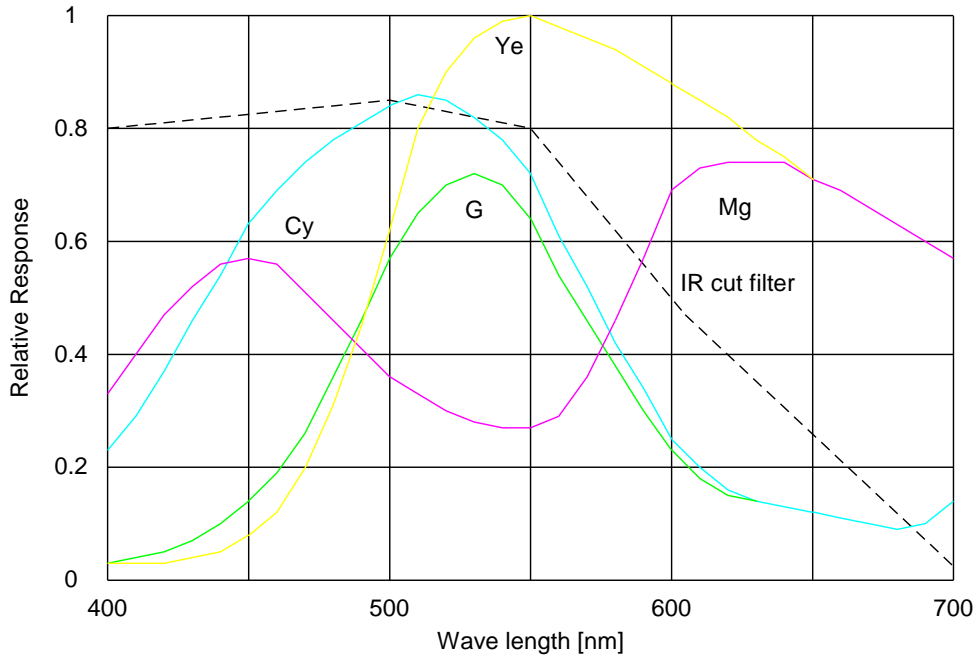

3.2 STC-R645 (ICX229AKB)

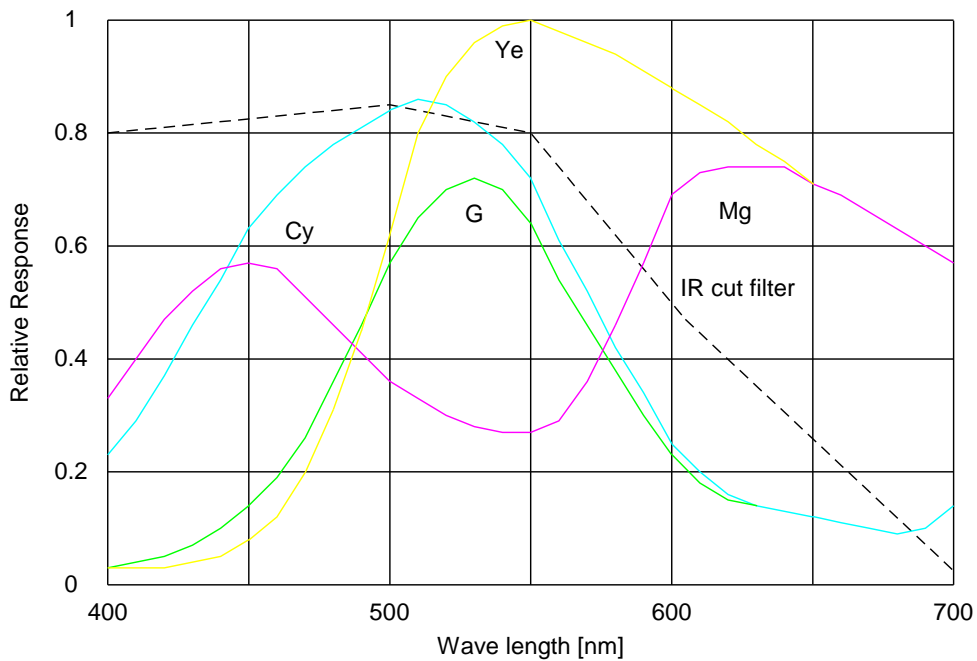

4 Switch Specifications

SW	No.	Function	OFF	ON
SW201	1	Shutter Mode	Electrical IRIS	Fixed Shutter
	2	Shutter Speed (SW201-1-ON: Available)		
	3			
	4			
	5			
	6	Flicker Compensation Mode (SW201-1-OFF: Available)		
	7	Back Light Compensation (SW201-1-ON: Available)	OFF	ON
	8	Back Light Correction Mode (SW201-7-ON: Available)	Auto Weight	Fixed Weight
SW202	1	Low Luminance Control (SW201-1-OFF: Available)	Note:AGC is available SW201-1 ON and OFF	
	2			
	3			
	4	WB	Auto	Push to Set
	5	Image Flip		
	6			
	7	Gamma	0.45(Preset)	1.0(Manual)
	8			

SW2	SW3	SW4	Shutter Speed
OFF	OFF	OFF	1/60
ON	OFF	OFF	1/125
OFF	ON	OFF	1/250
ON	ON	OFF	1/500
OFF	OFF	ON	1/1000
ON	OFF	ON	1/2000
OFF	ON	ON	1/4000
ON	ON	ON	1/10000

SW5	SW6	Flicker Compensation Mode
OFF	OFF	OFF
ON	OFF	Flicker Less
OFF	ON	Gain Modification
ON	ON	-

SW9	SW10	SW11	Low Luminance Control
OFF	OFF	OFF	AGC, Slow Shutter OFF
ON	OFF	OFF	AGC
OFF	ON	OFF	Slow Shutter ON
ON	ON	OFF	AGC -> Slow Shutter
OFF	OFF	ON	Slow Shutter -> AGC
ON	OFF	ON	AGC -> Slow Shutter -> AGC
OFF	ON	ON	-
ON	ON	ON	-

SW13	SW14	Image Flip
OFF	OFF	OFF(Normal)
ON	OFF	Vertical
OFF	ON	Horizontal
ON	ON	Horizontal Vertical

Factory Setting

SW	No.	OFF	ON
SW201	1	●	
	2	●	
	3	●	
	4	●	
	5	●	
	6	●	
	7	●	
	8	●	
SW202	1		●
	2	●	
	3	●	
	4	●	
	5	●	
	6	●	
	7	●	
	8	●	

Caution

- Internal Sync is unstable while adjusting the phase of input signal and output signal on External Sync
- External Sync may work even in Internal Sync [Factory Default] mode, however External Sync is not in phase with Internal Sync.
- To set the internal sync again, **please turn the camera OFF and ON after selecting Internal Sync.**

5 4 Description of each Back Panel (STC-R640/645)

5.1 Case: PWT Model

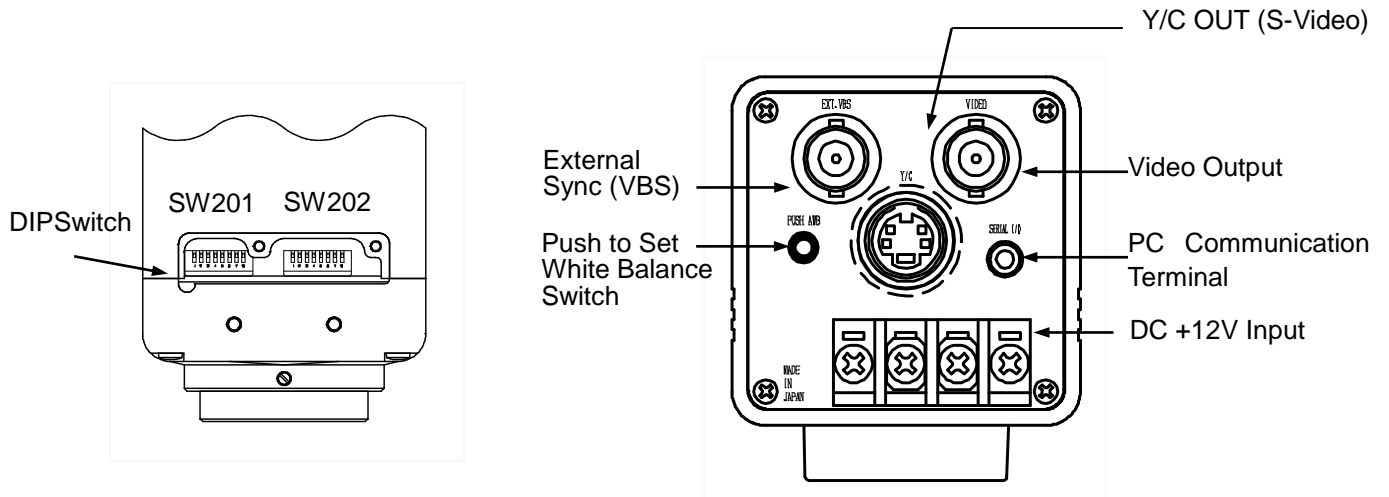

DC +12V Input

+12V Input: DC 9V to15V
Sentech Provide AC adopter : UN310-2P

Y/C OUT (S-Video)

Y/C Output

Pin 1	Y OUT(1Vp-p 75Ω)
Pin 2	C OUT(300mVp-p 75Ω)
Pin 3	GND(Y OUT)
Pin 4	GND(C OUT)

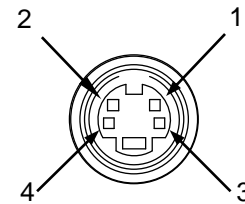

Video Output

BNC Connector (VBS 1.0Vp-p 75Ω)

External Sync(VBS)

BNC Connector, External Sync signal(VBS) input
Internal/External Sync (automatic select)

PC Communication Terminal

Configurable through Control Software "DQUCtrl" in the CD-ROM with RS-232C cable (Stereo Pin-jack / D-Sub Pin9).

DIP Switch

Refer to the Section "[Switch Specifications](#)".

5.2 Case: PWJ Model

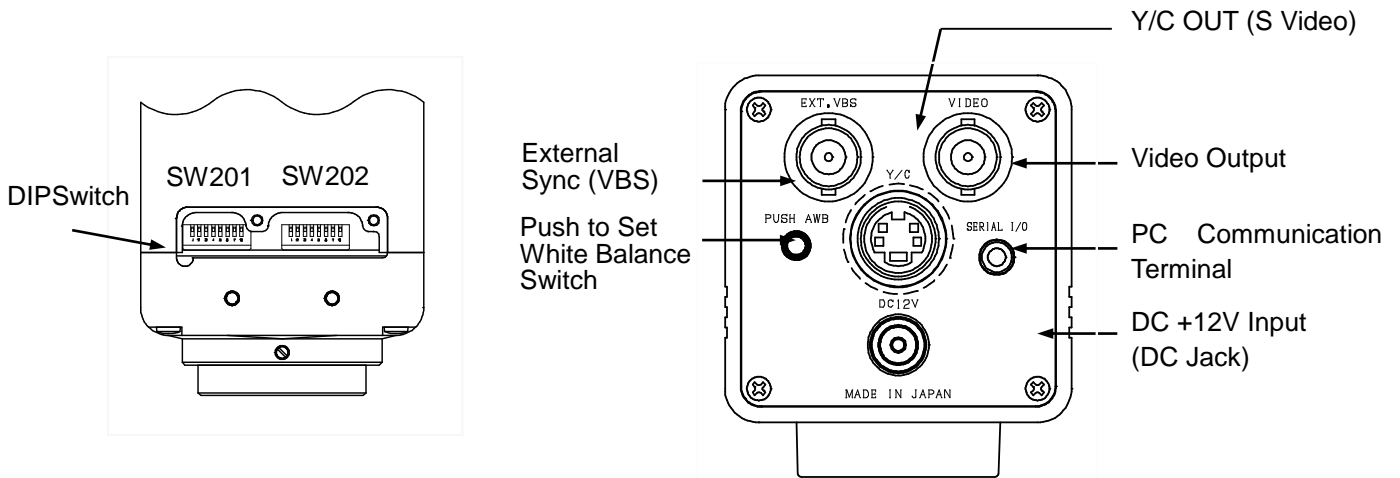

Y/C OUT (S-Video)

Y/C Output

Pin 1	Y OUT(1Vp-p 75Ω)
Pin 2	C OUT(300mVp-p 75Ω)
Pin 3	GND(Y OUT)
Pin 4	GND(C OUT)

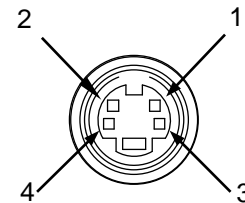

DC +12V Input(DC Jack)

+12V DC Jack(Center Plus) DC9V to 15V
Sentech Provide AC adopter : UN310-1210

BNC Connector

Video Output (VBS 1.0Vp-p 75Ω)

External Sync(VBS)

BNC Connector, External Sync signal (VBS) input
Internal/External Sync (automatic select)

PC Communication Terminal

Configurable through Control Software "DQUCtrl" in the CD-ROM with RS-232C cable (Stereo Pin-jack / D-Sub Pin9).

DIP Switch

Refer to the Section "[Switch Specifications](#)"

5.3 Case: PWC Model

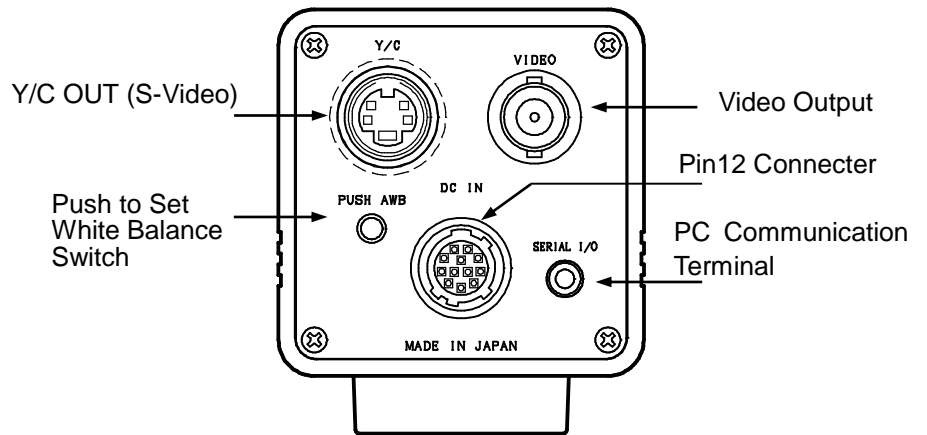
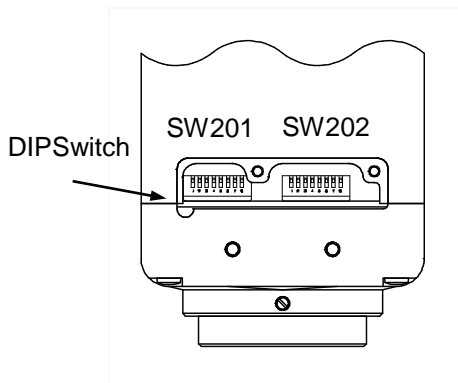

Y/C OUT (S-Video)

Y/C Output

Pin 1	Y OUT(1Vp-p 75Ω)
Pin 2	C OUT(300mVp-p 75Ω)
Pin 3	GND(Y OUT)
Pin 4	GND(C OUT)

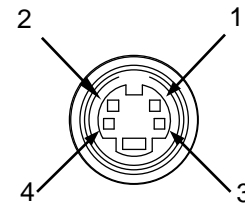

Pin12 Connector

Pin 1	GND
Pin 2	+12V
Pin 3	GND
Pin 4	Y OUT
Pin 5	GND(EXT HD)
Pin 6	EXT HD
Pin 7	EXT VD
Pin 8	GND
Pin 9	C OUT
Pin 10	GND
Pin 11	+12V
Pin 12	GND(EXT VD)

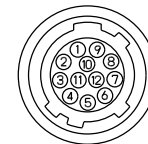

Connector : HR10A-10R-12PB (Hirose)

Note: The Y,C Signal on Pin12 and Y,C Signal on Y/C cannot be used simultaneously.

External Sync HD/VD

	NTSC(STC-620 Series)	NTSC(STC-630 Series)
Polarity	Active Low, Falling Edge	
External Sync	Automatic detection	
HD	HD signal(Pin6), HD GND(Pin5)	
VD	VD signal(Pin7), GND(Pin12)	
Frequency	HD 15.734kHz \pm 50ppm, VD 59.94Hz \pm 50ppm	HD 15.625kHz \pm 50ppm, VD 50.00Hz \pm 50ppm
HD, VD Amplitude	3 to 5v	
impedance	2.3K ohm	
Width	VD width: 9H(TYP), HD width 6 usec	

*Power Input only
BNC Connector

Sentech Provide AC adopter : UN310-12P
Video Output (VBS 1.0Vp-p 75 Ω)

PC Communication Terminal

Configurable through Control Software" DQUCtrl" in the CD-ROM with RS-232C cable (Stereo Pin-jack / D-Sub Pin9).

DIP Switch

Refer to the Section "[Switch Specifications](#)"

5.1 Board: P2,L2,CS2 Common Specification

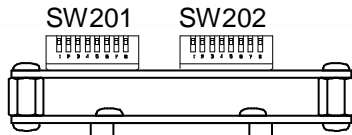

DIP Switch

Refer to the Section "[Switch Specifications](#)"

CN PIN

Refer to each Connector on the Section "[Dimensions](#)"

6 List of Fixed Lens

						diagonal	Horizontal	Vertical
Standard	2.7mm	LEN-R640-L2.7	f=	2.693 mm	F/2.0	100.3	78.9	58.3
Standard	4mm	LEN-R640-L4	f=	4.010 mm	F/2.5	65.5	51.9	38.7
Option	8mm	LEN-R640-L8	f=	8.000 mm	F/2.5	32.36	25.86	19.4
Option	16mm	LEN-R640-L16	f=	16.000 mm	F/2.5	16.05	12.86	9.67
Option	16mm	LEN-R640-L1611	f=	16.000 mm	F/11	16.05	12.86	9.67

*Note: C mount adapter is available.

7 Cable Length

2,3,5,10m

8 CCD Remote Head Shape

Straight Head (HD) type

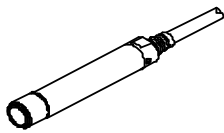

Fixed Lens Model

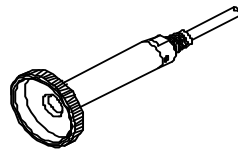

C Mount Model

L angle head (UHD) type

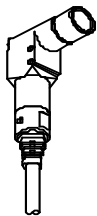

Fixed Lens Model

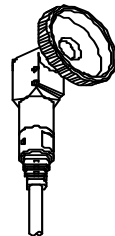

C Mount Model

L Angle Head (LHD) type

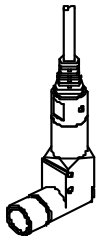

Fixed Lens Model



C Mount Model

9 Dimensions

9.1 CCD Remote Head

Straight Head (HD) type

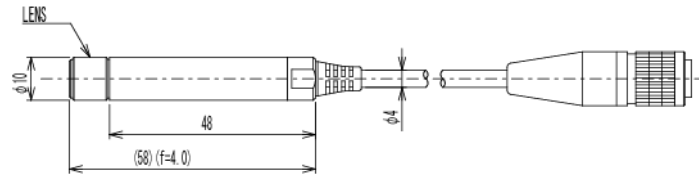

Unit: mm

L angle head (UHD) type

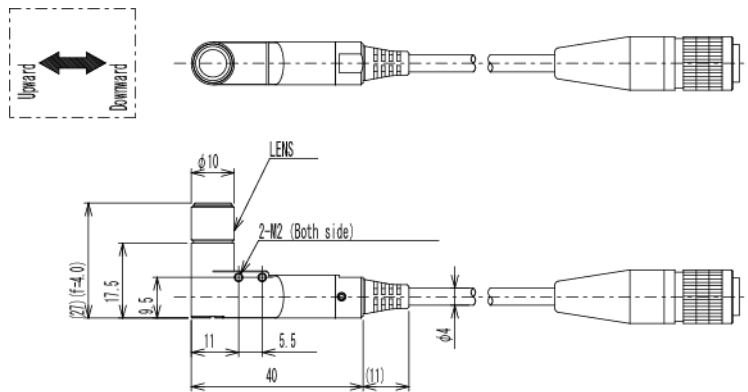

Unit: mm

L Angle Head (LHD) type

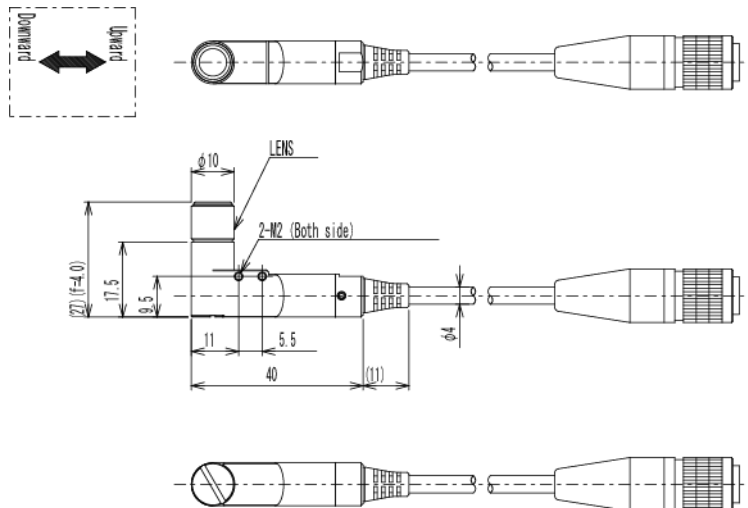

Unit: mm

9.2 Cased(C-Mount): PWT, PWJ, PWC

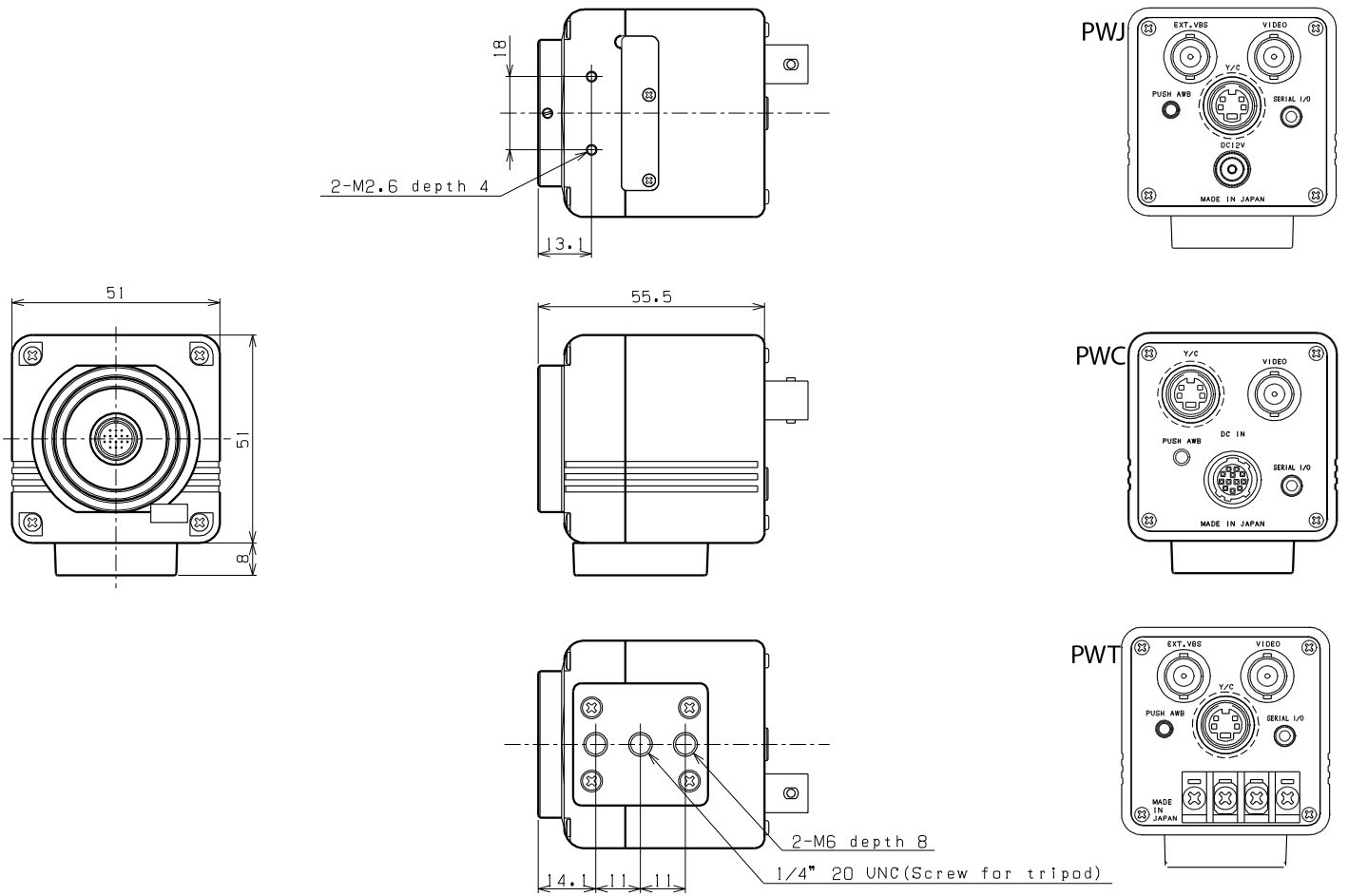

Unit : mm

9.3 Board

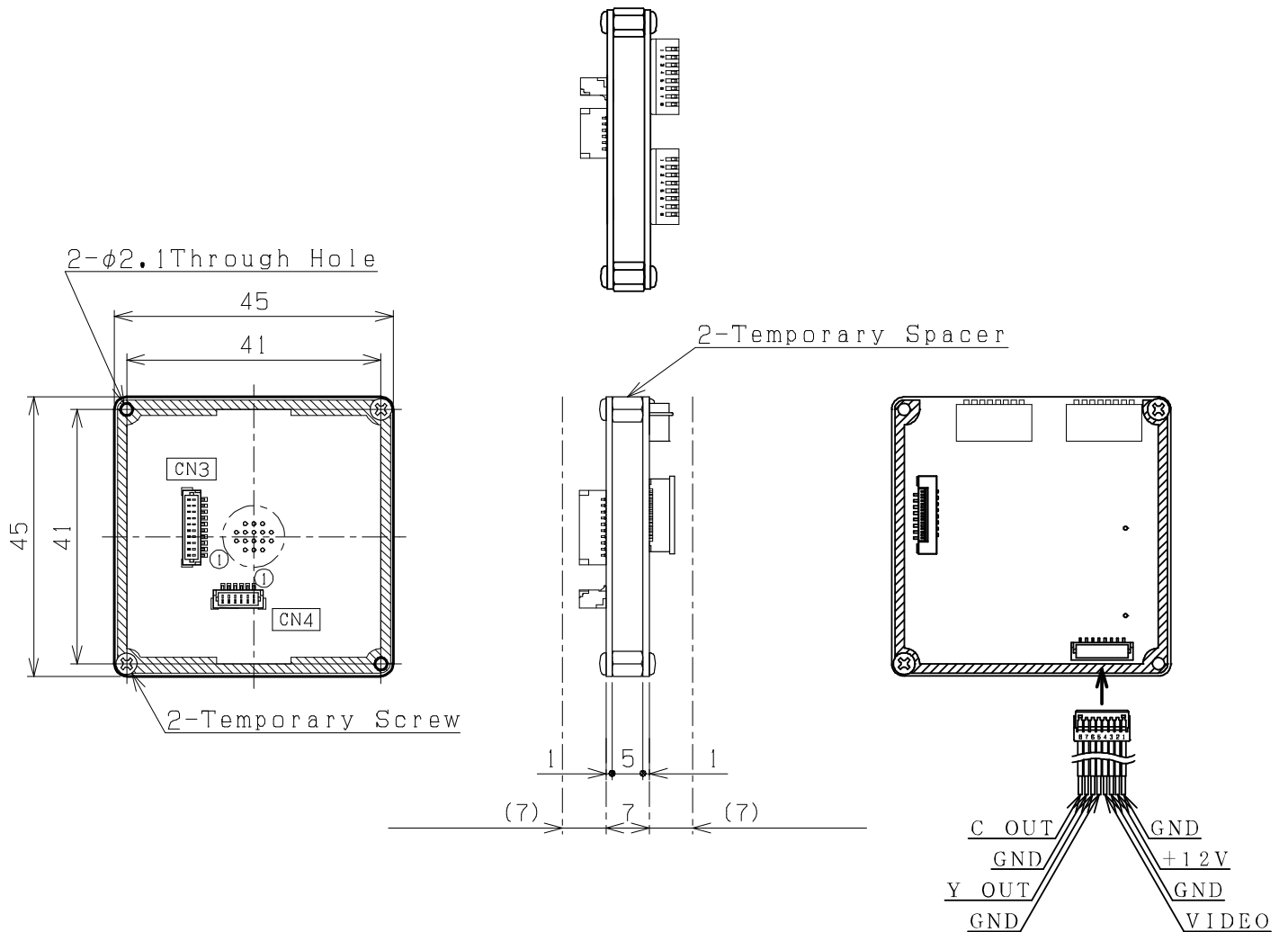

Unit : mm

10 Camera Set Up

When the user sets up the camera the following items may be required.

Camera: The model number of camera

Control Software: DQUCtrl,

Communication Cable: Serial Pin Jack cable (Serial Pin to RS232C Cable)

Power: DC 12V (Please refer to Section “**Error! Reference source not found. Error! Reference source not und.**”)

11 The communication protocol specifications and Control Software manual

11.1 Communication settings

Setting	Value
Baud rate	115,200bps
Data bit	8 bits
Parity	None
Stop bit	2 bits
Flow control	None

11.2 Communication format

The format for the sending / receiving data between the PC and the camera (DSP register or FLASHROM) is shown below:

11.2.1 Specifications of the sent commands

Function	1Byte	2Byte (COM)	3Byte	4Byte	5Byte	-----	-----
DSP register WRITE*	SW	57h	CAT	STB	DT0 --- DTn	CS	
DSP register READ	SW	52h	CAT	STB	ENB	CS	
FLASHROM WRITE (ALL Categories)	SW	7Ah	CS				
FLASHROM WRITE (1 Category)	SW	79h	CAT	CS			
FLASHROM WRITE (Byte)	SW	78h	CAT	STB	ENB	CS	
FLASHROM READ (Byte)	SW	58h	CAT	STB	ENB	CS	

* The packet byte length varies are depending on the length of the data strings (DT0 to DTn) to be written in the DSP registers.

The DSP registers data load from the FLASH ROM when power on the camera.

It is necessary to save data into the FLASH ROM to keep changing data before power off the camera.

Checkpoints:

DSP register WRITE (COM=57[h])

In order to write the Data into the DSP register on DT0 to DTn set the Category and Start Byte.
The maximum number of registers that can be written with one packet is 58 bytes.

DSP register READ (COM=52[h])

In order to read the Data from the DSP register on Start Byte to End Byte set the Category and Start Byte, End Byte.

The maximum number of registers that can be read with one packet is 60 bytes.

FLASHROM WRITE (ALL Categories) (COM=7A[h])

Write all of the current DSP register data into the FLASH ROM.

FLASHROM WRITE (1 Category) (COM=79[h])

Write the current DSP register data on one specific category into FLASH ROM.

FLASHROM WRITE (Byte) (COM=78[h])

Write the current DSP register data from start byte to end byte on one specific category into the FLASH ROM.

FLASHROM READ (COM=58[h])

Read the current DSP register data from start byte to end byte on one specific category on the FLASH ROM.

The maximum number of data inside the FLASH ROM that can be read with one packet is 60 bytes.

<Abbreviation symbols>

SW:	Start Word	Setting of the number of the valid bytes from SW and CS
COM:	Command	Setting of the commands and codes
CS:	Check Sum	Setting of the check sum from SW to CS
CAT:	Category	Setting of the target category Please refer to Section "11.3 Camera Control Command and Software Manual" for further information on this function.
STB:	Start Byte	Setting of the start byte (any setting from 1[h] to FE[h] can be selected)
ENB:	End Byte	Setting of the end byte (any setting from 1[h] to FE[h] can be selected)
DTn:	Data0 to Datan	Setting of the data to be written in the DSP register

Examples:

DSP register write (Write the data 0x20 to address category 09,0x64):

06,57,09,64,20,EA

06: 06 byte data
57: DSP register write
09: Category 09
64: Start byte 0x64
20: Write data 0x20
EA: Check Sum

DSP register read (Read the data on address category 09 from 0x64 to 0x65):

06,52,09,64,65,2A

06: 06 byte data
52: DSP register read
09: Category 09
64: Start byte 0x64
65: End byte 0x65
2A: Check Sum

All categories data write into FLASH ROM:

03,7A,7D

03: 03 byte data
7A: All categories data write into FLASH ROM
7D: Check Sum

One category data write into FLASH ROM (Write the all of data on category 09):

04,79,09,86

04: 04 byte data
79: One category data write into FLASH ROM
09: Category 09
86: Check Sum

11.2.2 Specifications of the received data

Function	1Byte	2Byte	3Byte	----	----	----
DSP register WRITE	SW	ST	CS			
DSP register READ	SW	ST	Read DT0 ---- Read DTn			CS
FLASHROM WRITE (ALL Categories)	SW	ST	CS			
FLASHROM WRITE (1 Category)	SW	ST	CS			
FLASHROM WRITE (Byte)	SW	ST	CS			
FLASHROM READ (Byte)*	SW	ST	Read DT0 ---- Read DTn			CS

* The packet byte length varies depending on the length of the data strings (DT0 to DTn) that have been read.

<Abbreviation symbols>

SW:	Start Word	The number of the valid bytes from SW and CS
ST :	Status Word	The sent command result Successful completion: Number of bytes received previously Unsuccessful completion: An error code Error codes F1[h]: Category number error F2[h]: Byte number error FE[h]: Check Sum error, Communication byte error
CS:	Check Sum	The check sum from SW to CS
DTn:	Data0 to Datan	Read data

#Example of Successful completion (DSP register WRITE)

Send: 0x06, 0x57, 0x09, 0x64, 0x20, 0xEA

6Byte
Number of bytes
received previously

06: 06 byte data
57: DSP register WRITE
09: Category 09
64: Start byte 0x64
65: Write data 0x20
EA: Check Sum

Receive: 0x03, 0x06, 0x09

03: 03 byte data
06: Number of bytes received previously
09: Check Sum

Detail of error code

0xF1 (Category number error)

When a non-existent category is selected on Memory Write or Read command, this error code is output.

#Example

Send: 0x06, 0x52, 0x20, 0x01, 0x01, 0x7A

Receive: 0x03, 0xF1, 0xF4

0x20 is a non-existent category, therefore ST return 0xF1.

0xF2(Byte number error)

When unavailable Start Byte or End Byte is selected on Memory Write or Read command, this error code is output.

#Example

Send: 0x06, 0x52, 0x03, 0xFE, 0xFE, 0x57

Receive: 0x03, 0xF2, 0xF5

0xFE is out of valuable range of Start Byte on Category 03, 0xF2 is output.

0xF3 (Communication format error)

When sending the command, the error on RS232C Communication format (e.g. over run error, framing error) comes up, this error code is output.

#Example

When 1StopBit was sent, even 2StopBit format is correct. This error code is output.

0xF4 (Time out error)

When the number of valid bytes is not received within a certain period, this error code is output.

#Example

Send: 0x06, 0x52, 0x03, 0x01, 0x01

Receive: 0x03, 0xF4, 0xF7

In this case data is received after a certain period.

In this case 1byte data did not receive (send) as CS, 0xF4 will be output after certain period.

0xFE (Check Sum error, Communication byte error)

When Check Sum (CS) or Transfer byte number is wrong, this error code is output.

#Example

Send: 0x06, 0x52, 0x03, 0x01, 0x01, 0x55

Receive: 0x03, 0xFE, 0x01

Check Sum was wrong (it should be 0x5D), 0xFE is output.

#Example

Send: 0x05, 0x52, 0x03, 0x01, 0x01, 0x5C

Receive: 0x03, 0xFE, 0x01

Total Byte number was wrong (it should be 0x06), 0xFE is output.

11.3 Camera Control Command and Software Manual

This camera can be controlled through the communication protocol or Control Software (DQUCtrl). Control Software has same functions. When the user would like to access the function register directory, the user can refer to the address information shown below

11.3.1 Port Driver Function

The Camera settings can be set through External Switch (SW201,202,PushSW),for a more detailed description, please refer to the Section ["Switch Specifications"](#).

When the camera setting changes through the External Switch (SW201,202,PushSW), the Port Driver should be "ON". If the Port Driver is set "OFF", the External Switch (SW201,202,PushSW) setting will not be reflected.

However, when the camera settings change through the Control Software, the Port Driver should be "OFF" before the register is set. If the Port Driver is set "ON", the External Switch (SW201,202,PushSW) setting will be reflected.

When the Port Driver is "ON", the External Switch (SW201,202,PushSW) setting is still available.

Below is an example of how to use the Port driver on AWB Mode.

The related register with the Port Driver function is in the rectangular box on the Control Software (DQUCtrl).

(e.g. Upper right side in the rectangular box: Port Driver function's combo box, Bottom side in the rectangular box: AWB Mode's combo box,)

Port Driver Function(SW202_4-PWB) [02H]ON

AWB Mode [C05_001H.0-3] [00H]ATW

When the Port Driver Function is "ON", the External Switch(SW201,202,PushSW) should work. Under this condition, AWB mode cannot be controlled through the Control Software.

Port Driver Function(SW202_4-PWB) [02H]ON

AWB Mode [C05_001H.0-3] [00H]ATW

Port Driver Function : Disable for "ON"

If the user would like to control AWB Mode through the Control Software, the Port Driver Function should be set to "OFF".

When the Port Driver Function is "OFF", the Control Software can control this function.

However when the Port Driver Function is "OFF", the External Switch's settings are disabled. Therefore AWB cannot be controlled through the External Switch.

Port Driver Function(SW202_4-PWB) [00H]OFF

AWB Mode [C05_001H.0-3] [00H]ATW

Port Driver Function : enable for "OFF"

11.3.2 Shutter/Gain



Select AE Mode (AEMODE)

Selects the AE control mode

AE mode has to be set as “Auto exposure (AEME = 0 (0h))” to activate this mode selection. AEMODE can control middle- and high-brightness areas on AE. When user set this parameter through Control Software (DQUCtrl), please turn off the Port Driver (For further information regarding the Port Driver, please refer to the Section [Port Driver Function](#)).

Category: 03d

Start byte: 002H.0-2

Condition: [AEME](#) = 0 (0h) (AE mode)

Setting: 0 (0h) to 2 (2h)

Selection:

0h: Shutter

1h: Reserved

2h: Shutter Fix

Detailed description of AEMODE

SHTMAX, SHTMIN described in this section refers to the upper limit of the electronic shutter speed and the lower limit of the electronic shutter speed, respectively.

The upper limits of the electronic shutter speed are set using the SHTMAXML, SHTMAXL, SHTMAXH and SHTMAXM parameters.

The lower limits of the electronic shutter speed are set using the SHTMINML, SHTMINL, SHTMINH and SHTMINMH parameters.

For details on the electronic shutter speed range settings, refer to the Sections “[AE minimum exposure time](#)”, “[AE maximum exposure time](#)”.

AEMODE=0[h] Shutter

In this mode, auto exposure control is exercised in the middle- and high-brightness areas using the electronic shutter. The electronic shutter speed is controlled across a range from SHTMIN and SHTMAX.

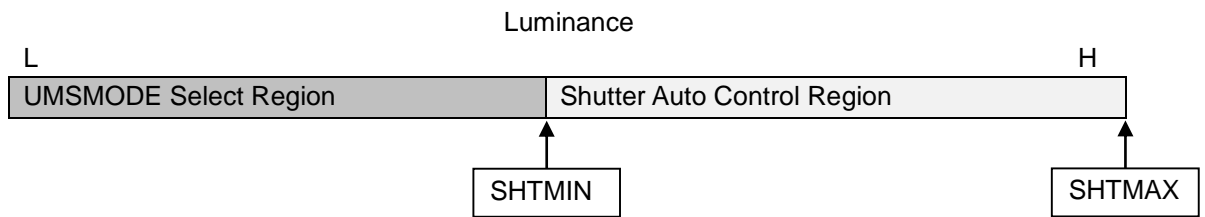

AEMODE=2[h] Shutter Fix

In this mode, the electronic shutter value is fixed. Used as the electronic shutter value is the setting selected by ME. For further information regarding ME, please refer to Section [3.3.7 ME](#).

AE User Reference Level (AEREFLVL)

When control is exercised using the mechanical iris and electronic shutter, AE operates so that the brightness converges at the base reference position.

When the base reference is set high, the brightness converges at a high position; when it is set low, it converges at a low position.

Category: 03d

Start byte: 003H.0-004H.1

Condition: [AEME](#) = 0 (0h) (AE mode)

Setting: 0 (0h) to 1023 (3FFh)

AE Speed (AESPEED)

The convergence speed of AE can be adjusted. If the convergence speed is too high, AE may oscillate near the convergence position. The AE oscillation can be prevented by adjusting the convergence speed.

The higher the AESPEED parameter setting, the lower the convergence speed; conversely, the lower the parameter setting, the higher the speed.

Sets the AE convergence speed

AE Base Reference Level

AE mode has to be set as "Auto exposure (AEME = 0 (0h))" to activate this AE convergence speed setting

Category: 03 d

Start byte: 009H.0-7

Condition: [AEME](#) = 0 (0h) (AE mode)

Setting: 0 (0h) to 255 (FFh)

Selection:

0[h] (fast) to FF[h] (slow)

AE Dead Band (AEDBAND)

The dead bands are provided to ensure that AE will not track the very minor changes in the brightness. AE operates only when the brightness has changed from the convergence level by an amount exceeding the values set by the dead bands.

The dead bands are adjusted by the following parameters, and can be adjusted only for the AGC control area and the low-speed shutter area. Increasing the value widens the dead band, and makes it more difficult for AE to follow changes in the brightness.

Sets the dead bands for the AGC control area and the low-speed shutter area
 AE mode has to be set as "Auto exposure (AEME = 0 (0h))" to activate this AE dead band adjustment setting

- Category: 03 d
- Start byte: 00BH.0-7
- Condition: [AEME](#) = 0 (0h) (AE mode)
- Setting: 0 (0h) to 255 (FFh)
- Selection:
 - 0[h] (no dead band) to FF[h] (maximum dead band)

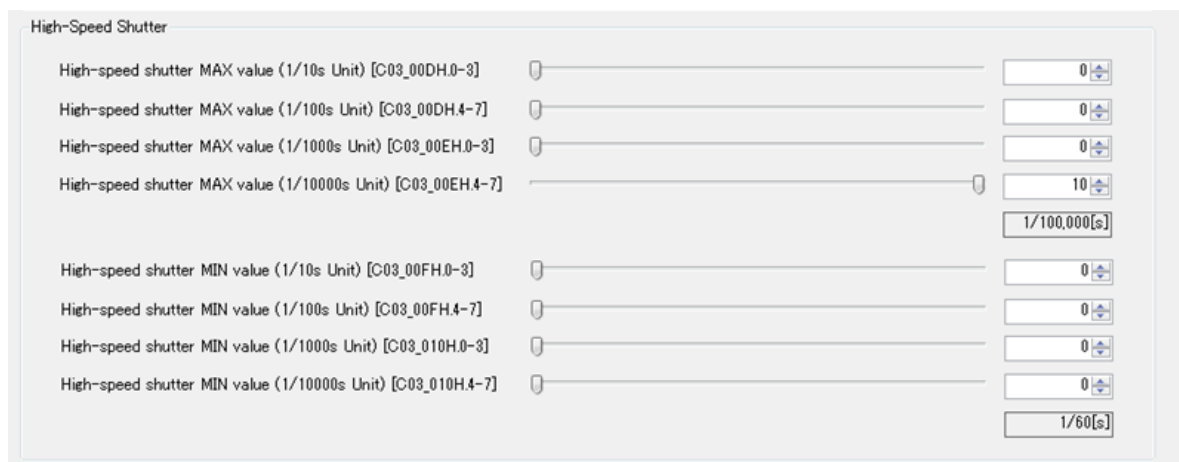

AE minimum exposure time

Sets the minimum exposure time for the auto exposure control

High-speed shutter MAX value (1/10s Unit) SHTMAXML : Shutter upper limit: Set the denominator of the 1/10[s] digit.
 High-speed shutter MAX value (1/100s Unit) SHTMAXL : Shutter upper limit: Set the denominator of the 1/100[s] digit.
 High-speed shutter MAX value (1/1000s Unit) SHTMAXH : Shutter upper limit: Set the denominator of the 1/1,000[s] digit.
 High-speed shutter MAX value (1/10000s Unit) SHTMAXMH : Shutter upper limit: Set the denominator of the 1/10,000[s] digit.

	SHTMAXML	SHTMAXL	SHTMAXH	SHTMAXMH
Outline	The minimum exposure time for the auto exposure control			
Category	03d			
Start byte	00DH.0-3	00DH.4-7	00EH..0-3	00EH..4-7
Setting	0 (0h) to 9 (9h)	0 (0h) to 9 (9h)	0 (0h) to 9 (9h)	0 (0h) to 10 (Ah)
Selection	Sets the denominator of the 1/10[s] digit	Sets the denominator of the 1/100[s] digit	Sets the denominator of the 1/1000[s] digit	Sets the denominator of the 1/10000[s] digit

In order to set the exposure time; 1/60 to 1/100,000 seconds on NTSC, 1/50 to 100,000 seconds on PAL, use the following command:

Category: 03d

Start byte: 13d.0

Condition: [AEME](#) = 0 (0h) (AE mode), AEMODE = 0(h)

AE maximum exposure time

Sets the maximum exposure time for the auto exposure control

High-speed shutter MIN value (1/10s Unit) SHTMINML : Shutter lower limit: Set the denominator of the 1/10[s] digit.

High-speed shutter MIN value (1/100s Unit) SHTMINL : Shutter lower limit: Set the denominator of the 1/100[s] digit.

High-speed shutter MIN value (1/1000s Unit) SHTMINH : Shutter lower limit: Set the denominator of the 1/1,000[s] digit.

High-speed shutter MIN value (1/10000s Unit) SHTMINMH : Shutter lower limit: Set the denominator of the 1/10,000[s] digit.

	SHTMINML	SHTMINL	SHTMINH	SHTMINMH
Outline	The maximum exposure time for the auto exposure control			
Category	03d			
Start byte	00FH..0-3	00FH..4-7	010H.0-3	010H.4-7
Setting	0 (0h) to 9 (9h)	0 (0h) to 9 (9h)	0 (0h) to 9 (9h)	0 (0h) to 10 (Ah)
Selection	Sets the denominator of the 1/10[s] digit	Sets the denominator of the 1/100[s] digit	Sets the denominator of the 1/1000[s] digit	Sets the denominator of the 1/10000[s] digit

In order to set the exposure time; 1/60 to 1/100,000 seconds on NTSC, 1/50 to 100,000 seconds on PAL, use the following command:

Category: 03d

Start byte: 15d.0

Condition: [AEME](#) = 0 (0h) (AE mode), AEMODE = 0(h)

Setting: 000A

Examples:

Set the shutter speed to 1/250[s].

SHTMAXML → 5 (1/10s digit) SHTMINML → 5 (1/10s digit)

SHTMAXL → 2 (1/100s digit) SHTMINL → 2 (1/100s digit)

SHTMAXH → 0 (1/1,000s digit) SHTMINH → 0 (1/1,000s digit)

SHTMAXMH → 0 (1/10,000s digit) SHTMINMH → 0 (1/10,000s digit)

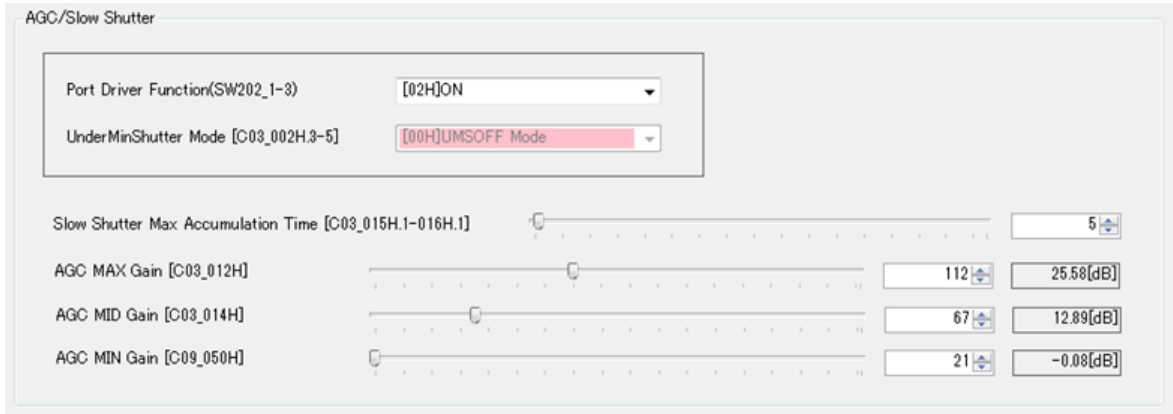

Under MinShutter Mode (UMSMODE)

Selects the AE control mode (low-brightness areas)

AE mode has to be set as “Auto exposure (AEME = 0 (0h))” to activate this AE control mode selection for the low brightness areas. when user set this parameter through Control Software (DQUCtrl), please turn off the Port Driver (For further information regarding the Port Driver, please refer to the Section [Port Driver Function](#)).

Category: 03 d

Start byte: 002H.3-5

Condition: [AEME](#) = 0 (0h) (AE mode), [Port Driver Function](#) (SW202.1-3) = “ON”

Setting: 0 (0h) to 5 (5h)

Selection:

- 0h: UMSOFF Mode
- 1h: AGC Mode
- 2h: SLOW Shutter Mode
- 3h: AGC -> SLOW Shutter
- 4h: SLOW Shutter -> AGC
- 5h: AGC -> SLOW Shutter -> AGC

Detailed description of UMSMODE

One of the following six modes for UMSMODE (under min. shutter modes) can be selected as the control method under low-brightness conditions where the sufficient exposure cannot be achieved using the electronic shutter or mechanical iris.

UMSMODE=0[h] UMSOFF Mode

In this mode, no exposure control is exercised in the low-brightness areas.

AGC is fixed at the gain value which was set using the AGCMIN parameter (CAT9_Byte80_bit0-7).

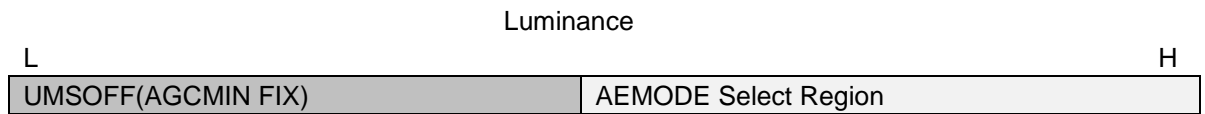

UMSMODE=1[h] AGC Mode

In this mode, auto exposure control is exercised over the low-brightness areas using AGC. The control range for AGC is set using the AGCMIN and AGCMAX.

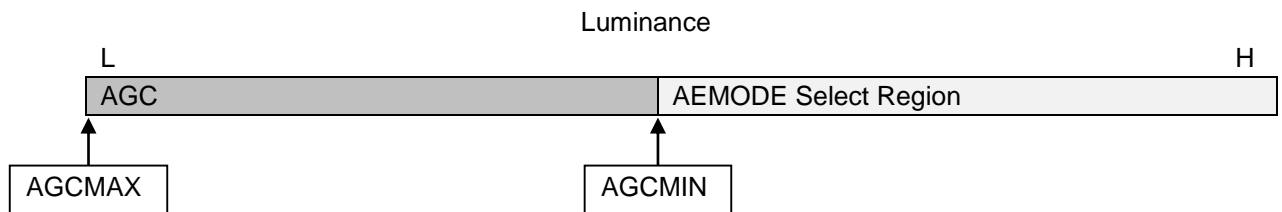

UMSMODE=2[h] SLOW Shutter Mode

In this mode, auto exposure control is exercised in the low-brightness areas using the low-speed shutter. The maximum storage time is set using SLOWMAX.

This time can be set in 1-field increments, and a maximum of 512 fields can be stored.

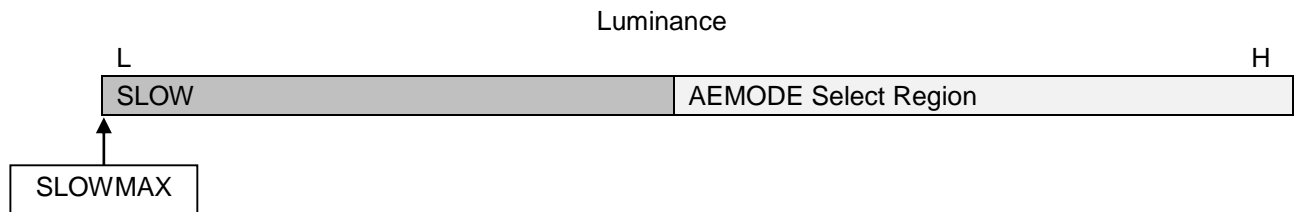

UMSMODE=3[h] AGC -> AGC -> SLOW Shutter

In this mode, auto exposure control is exercised in the low-brightness areas using AGC and the low-speed shutter.

When a low-brightness area is entered from a middle-brightness area, AGC control is exercised first. When the gain value of AGC reaches its maximum, operation transfers to low-speed shutter control. The control range for AGC is set using the AGCMIN and AGCMAX parameters. The maximum storage time of the low-speed shutter is set using SLOWMAX. The AGCMAX value serves as the AGC gain value in the low-speed shutter control area.

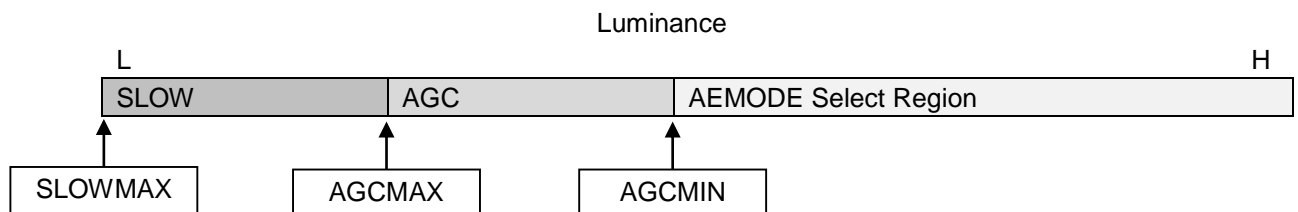

UMSMODE=4[h] SLOW -> SLOW Shutter -> AGC

In this mode, auto exposure control is exercised in the low-brightness areas using the low-speed shutter and AGC. When a low-brightness area is entered from a middle-brightness area, low-speed shutter control is exercised first.

When the storage time of the low-speed shutter reaches its maximum, operation transfers to AGC control.

The maximum storage time of the low-speed shutter is set using SLOWMAX. The control range for AGC is set using the AGCMIN and AGCMAX parameters. The SLOWMAX value serves as the electronic shutter value in the AGC control area.

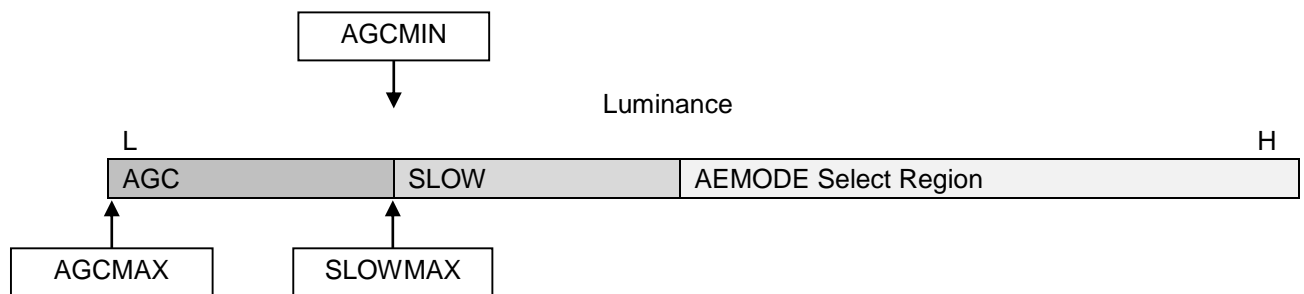

UMSMODE=5[h] AGC -> AGC -> SLOW Shutter -> AGC

In this mode, the signal-to-noise ratio and dynamic resolution can be adjusted by dividing the low-brightness areas into three control areas and by inserting the low-speed shutter area inside the AGC area. When a low-brightness area is entered from a middle-brightness area, AGC control is exercised first. When the gain value of AGCMID is reached, operation transfers to low-speed shutter control. Then, when the storage time of the low-speed shutter reaches its maximum, operation returns to AGC control. The AGC control range is set using the AGCMIN, AGCMID and AGCMAX parameters. The maximum storage time of the low-speed shutter is set using SLOWMAX.

The value which was set by AGCMID serves as the AGC gain value in the low-speed shutter control area. The value which was set by SLOWMAX serves as the shutter value in the AGC control area after low-speed shutter control.

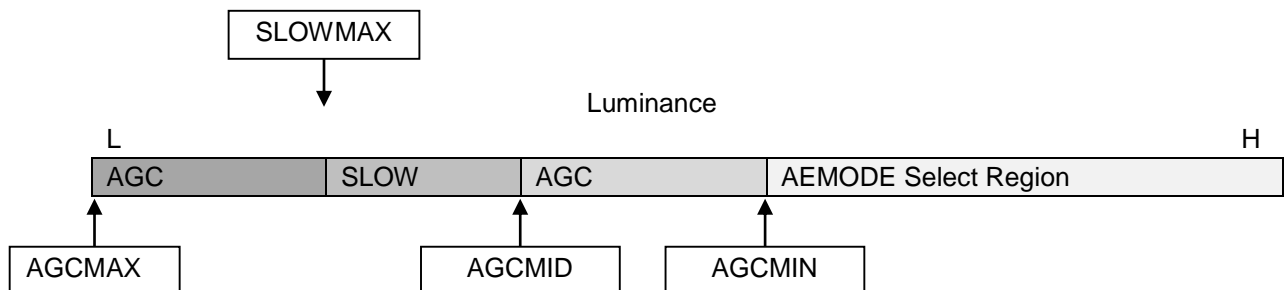

* Set the maximum value (AGCMAX), minimum value (AGCMIN) and boundary value (AGCMID) of the AGC gain in such a way that all three values stand in the proper correlation to one another. (AGCMAX > AGCMID > AGCMIN)

Low-speed shutter control is exercised within the predetermined range of the number of storage fields. The

upper limit of the number of storage fields can be set as desired.

Slow Shutter Max Accumulation Time (SLOWMAX)

Sets the upper limit of the number of low-speed shutter storage fields

Category: 03 d

Start byte: 015H.1-016H.1

Condition: [AEME](#) = 0 (0h) (AE mode), [UMSMODE](#) = 2,3,4,5(h)

Setting: 0 (0h) to 511 (1FFh)

Selection:

The upper limit of the number of storage fields can be set in the 1 to 512 range.

Number of storage fields [FLD] = Setting + 1

AGC MAX Gain (AGCMAX)

Sets the maximum gain for the AGC control

Category: 03 d

Start byte: 012H.0-7

Condition: [AEME](#) = 0 (0h), [UMSMODE](#)=1,3,4,5(h),

Setting: 0 (0h) to 255 (FFh)

Selection:

00 - FF[h]

*Note: Configurable value depends on camera model.

AGC MID Gain (AGCMID)

Sets the boundary value of the AGC gain

The boundary value of the AGC gain has to be smaller than the maximum gain (AGCMAX) and the greater than the minimum gain (AGCMIN) for the AGC control.

Category: 03 d

Start byte: 014H.0-7

Condition: [UMSMODE](#) = 5 (5h) , [AGCMAX](#) > [AGCMID](#) > [AGCMIN](#)

Setting: 0 (0h) to 255 (FFh)

Selection:

00 - FF[h]

*Note: Configurable value depends on camera model.

AGC MIN Gain (AGCMIN)

Sets the minimum gain for the AGC control

Category: 09 d

Start byte: 050H.0-7

Condition: -

Setting: 0 (0h, low gain) to 255 (FFh, high gain)

Selection:

00 - FF[h]: Low gain - High gain

*Note: Configurable value depends on camera model.

11.3.3 Chroma

High Luminance Chroma Suppress

High Luminance Chroma Suppress Selection [C02_03DH.2]

High Luminance Chroma Suppress Threshold [C02_03DH.3-03EH.4]

High Luminance Chroma Suppress Step Width [C02_03EH.5-03FH.0]

High Luminance Chroma Suppress Selection(CSHLON)

Sets the high-brightness chroma suppression function to ON or OFF.

Category: 02 d
 Start byte: 03DH.2
 Condition: -
 Selection:

0[h] : OFF
 1[h] : ON

High Luminance Chroma Suppress Threshold(CSHLTH)

Sets the high-brightness chroma suppression brightness threshold.
 If the boundary value is set too low, even the Normal Luminance Chroma Suppress might reach high luminance and suppress the normal Chroma signal.

Category: 02 d
 Start byte: 03DH.3-03EH.4
 Condition: -
 Setting: 000 (0h) to 1023 (3FFh) (low to high)

High Luminance Chroma Suppress Step Width(CSHLSTEP)

Sets the high-brightness chroma suppression step width 0[h] to F[h] (sharp to smooth)

Category: 02 d
 Start byte: 03EH.5-03FH.0
 Condition: -
 Setting: 0 (0h) to 15 (Fh) (sharp to smooth)

Low Luminance Chroma Suppress

Low Luminance Chroma Suppress Selection [C02_03FH.1] [01H]ON

Low Luminance Chroma Suppress Threshold [C02_03FH.2-040H.3] 26

Low Luminance Chroma Suppress Step Width [C02_040H.4-7] 1

Low Luminance Chroma Suppress Selection(CSLLON)

The low-brightness chroma suppression function suppresses the chroma signal level in the low-brightness (low signal-to-noise ratio) areas to make the color noise inconspicuous. It treats brightness below the threshold level as noise, and suppresses the colors in those areas. Sets the low-brightness chroma suppression function to ON or OFF.

Category: 02 d
 Start byte: 03FH.1
 Condition: -
 Selection:

0[h] : OFF
 1[h] : ON

Low Luminance Chroma Suppress Threshold(CSLLTH)

Chroma suppression is applied to the brightness levels below the CSLLTH setting, but bear in mind that if CSLLTH is set too high, the normal brightness areas will also be treated as low-brightness areas and the normal chroma signals will also be suppressed.

Category: 02 d
 Start byte: 03FH.2 - 040H.3
 Condition: -
 Setting: 0 (0h) to 1023 (3FFh) (low to high)

Low Luminance Chroma Suppress Step Width(CSLLSTEP)

Sets the low-brightness chroma suppression function to ON or OFF.

Category: 02 d
 Start byte: 040H.4-7
 Condition: -
 Setting: 0 (0h) to 15 (Fh) (sharp to smooth)

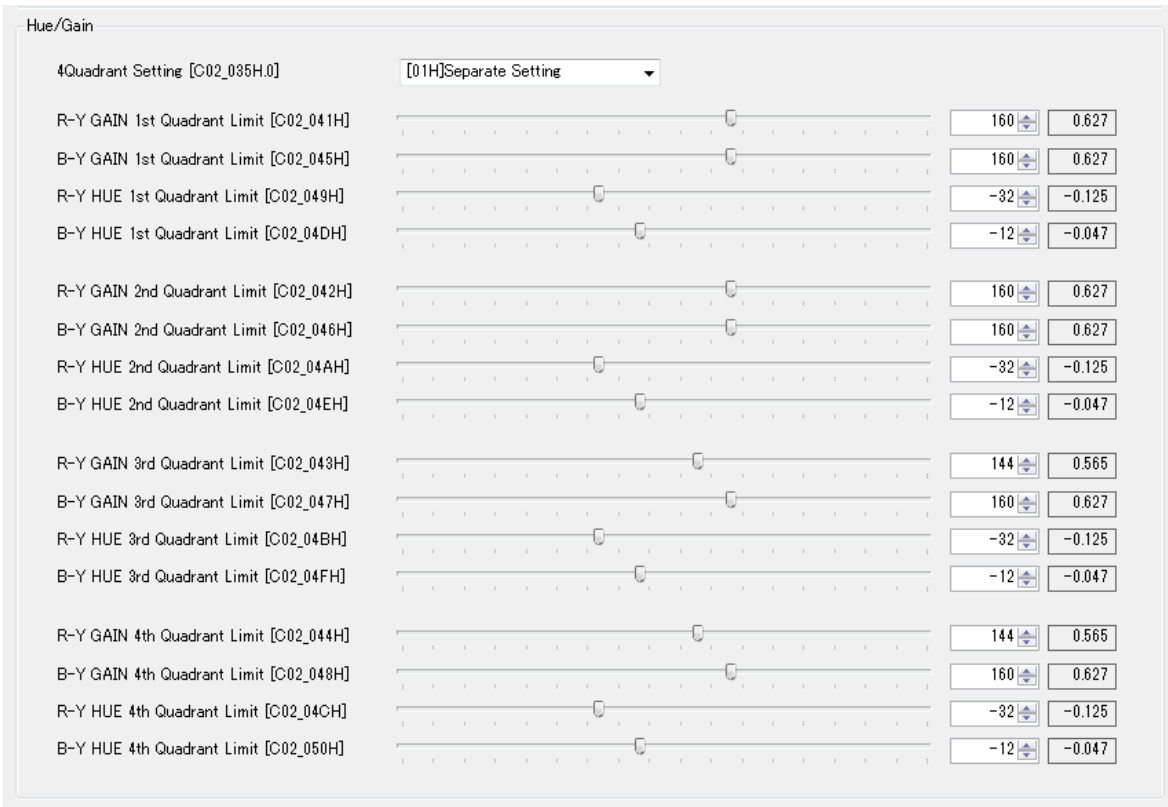

4Quadrant Setting (CNEGPOS)

Chroma signal negative/positive reversal function.

Category: 02 d

Start byte: 040H.4-7

Condition: -

Setting: 0 (0h) to 1 (1h)

0[h]: Simultaneous Setting 1[h] : Separate Setting

R-Y GAIN Quadrant Limit,

Users can use the hue and gain adjustments to adjust the colors to their preference by setting the color gain parameters (RYGAIN0-4, BYGAIN0-4) and phase parameters (RYHUE0-4, BYHUE0-4). There are two setting options: the 4-quadrant simultaneous setting which is used to adjust all four quadrants using only the parameters of the first quadrant, and the 4-quadrant separate setting which is used to adjust each of the four quadrants separately. The 4-quadrant separate setting enables color adjustments with a greater degree of freedom.

Parameter	Address	Description
R-Y GAIN 1st to 4th Quadrant Limit (RYGAIN0-4)	Category: 02 d Start byte: 041H_bit0 to 050H_bit7	Adjusts the R-Y GAIN in quadrants 1 to 4
R-Y GAIN 1st to 4th Quadrant Limit (BYGAIN0-4)		Adjusts the B-Y GAIN in quadrants 1 to 4
R-Y Hue1st to 4th Quadrant Limit (RYHUE0-4)		Adjusts the R-Y Hue in quadrants 1 to 4
B-Y Hue 1st to 4th Quadrant Limit (BYHUE0-4)		Adjusts the B-Y Hue in quadrants 1 to 4

Note:

Be very careful with the settings when setting the HUE and GAIN to be adjusted separately for the four quadrants since problems may occur in the color reproduction along the boundaries between the quadrants if considerably different gain and hue settings are established for each quadrant.

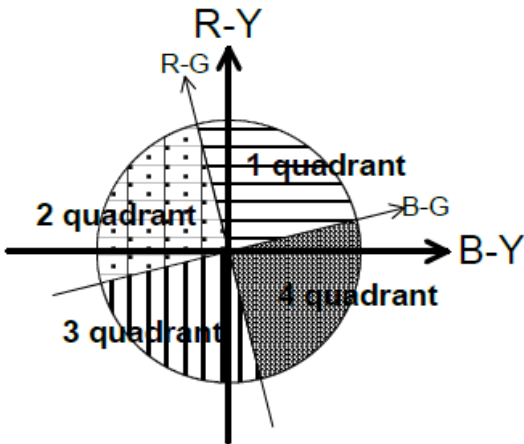

11.3.4Gamma

Gamma Mode	
Gamma Function Mode [C02_00DH.0]	[01H]Preset Mode
Preset Mode Settings	
Y Gamma Level [C02_00DH.4-7]	[05H]2.2
Y Knee Level [C02_00EH.0-3]	[05H]114%
Chroma Gamma Level [C02_00EH.4-7]	[02H]1.6
Chroma Knee Level [C02_00FH.0-3]	[05H]114%

It is possible to select one of two gamma operations--the preset mode operation or user mode operation--by setting the GAMMAMODE parameter.

Gamma Function Mode(GAMMAMODE)

Sets the Y variable gamma

Category: 02 d

Start byte: 00DH.0

Condition: -

Setting: 0 (0h) to 1 (1h)

Selection:

0h: Manual <= This mode cannot be selected through control software.

1h: Preset mode

In each of these modes, the gamma curve can be set separately for the luminance (Y) signal and chroma signal.

In the preset mode, any of nine predetermined gamma curves can be selected using the four parameters of

[YGAM](#) · [YNKEE](#) · [CGAM](#) · [CKNEE](#)...

Y Gamma level (YGAM)

Sets the Y variable gamma

This DSP value describe the reciprocal value, the Gamma value on camera should be reciprocal.

Category: 02 d

Start byte: 00DH..4-7

Condition: GAMMAMODE = 1

Setting: 0 (0h) to 8 (8h)

Selection:

0h: Gamma = 1.2 (Gamma = 0.83)

1h: Gamma = 1.4 (Gamma = 0.71)

2h: Gamma = 1.6 (Gamma = 0.62)

3h: Gamma = 1.8 (Gamma = 0.55)

4h: Gamma = 2.0 (Gamma = 0.50)

5h: Gamma = 2.2 (Gamma = 0.45)

6h: Gamma = 2.4 (Gamma = 0.41)

7h: Gamma = 2.6 (Gamma = 0.38)

8h: Gamma = 1.0 (Gamma = 1.00)

Y Knee level (YKNEE)

Set the Y variable knee

Category: 02 d

Start byte: 00EH.0-3

Condition: GAMMAMODE = 1

Setting: 0 (0h) to 8 (8h)

Selection:

0h: 104%

1h: 106%

2h: 108%

3h: 110%

4h: 112%

5h: 114%

6h: 116%

7h: 118%

8h: Max output signal

The low-brightness side with an output level up to 100% is the Y gamma area. The gamma curve has an increasingly higher output level as the YGAM preset value is increased from 0[h] to 7[h]. A setting of 8[h] selected for YGAM produces gamma characteristics where the input and output levels up to 100% are connected by a straight line. The high-brightness side with input and output levels in excess of 100% is the Y knee area. The gradient of the knee characteristics becomes increasingly lower as the YKNEE preset value is decreased from 7[h] to 0[h].

Chroma Gamma level (CGAM)

Set the C variable gamma.

This DSP value describe the reciprocal value, the Gamma value on camera should be reciprocal.

Category: 02 d

Start byte: 14 d.4-7

Condition: GAMMAMODE = 1

Setting: 0 (0h) to 8 (8h)

Selection:

0h: Gamma = 1.2 (Gamma = 0.83)

1h: Gamma = 1.4 (Gamma = 0.71)

2h: Gamma = 1.6 (Gamma = 0.62)

3h: Gamma = 1.8 (Gamma = 0.55)

4h: Gamma = 2.0 (Gamma = 0.50)

5h: Gamma = 2.2 (Gamma = 0.45)

6h: Gamma = 2.4 (Gamma = 0.41)

7h: Gamma = 2.6 (Gamma = 0.38)

8h: Gamma = 1.0 (Gamma = 1.00)

Chroma Kneel level (CKNEE)

Set the C variable kneel

Category: 02 d

Start byte: 15 d.0-3

Condition: GAMMAMODE = 1

Setting: 0 (0h) to 8 (8h)

Selection:

0h: 104%

1h: 106%

2h: 108%

3h: 110%

4h: 112%

5h: 114%

6h: 116%

7h: 118%

8h: Max output signal

Any chroma gamma and knee level can be set by combining one of nine chroma gamma curves using CGAM with one of nine chroma knee levels using CKNEE. The low-range side with an output level up to 100% is the chroma gamma area. The gamma curve has an increasingly higher output level as the CGAM preset value is increased from 0[h] to 7[h]. A setting of 8[h] selected for CGAM produces gamma characteristics where the input and output levels up to 100% are connected by a straight line. The high-range side with input and output levels in excess of 100% is the chroma knee area. The gradient of the knee characteristics becomes increasingly lower as the CKNEE preset value is decreased from 8[h] to 1[h]. A setting of 0[h] selected for CKNEE produces knee characteristics which connect a level up to the maximum

11.3.5BLC

The backlight compensation function provides compensation by increasing the brightness of the overall screen so that subjects being shot with a loss of dark detail due to backlight will have just the right brightness level.

Back Light Compensation Switch (BLCON)

When using the backlight and excessive front lighting compensation functions, set 1[h] (ON) for the BLCON. When a user sets this parameter through the Control Software (DQUCtrl), please turn off the Port Driver (For further information regarding the Port Driver, please refer to the Section [Port Driver Function](#)).

Category: 03d
 Start byte: 01EH.0
 Condition: [AEME](#) = 0 (0h) (AE mode),
 Setting: 0 (0h) to 1 (1h)
 Selection:
 0h: OFF
 1h: ON

Back Light Compensation Function (BLCMODE)

Selects the backlight compensation function mode
 When the user sets this parameter through the Control Software (DQUCtrl), please turn off the Port Driver (For further information regarding the Port Driver, please refer to the Section [Port Driver Function](#)).

Category: 03d
 Start byte: 01EH.1-2
 Condition: [AEME](#) = 0 (0h) (AE mode), [Port Driver Function](#) (SW201.8) = "ON"
 Setting: 0 (0h) to 3 (3h)
 Selection:
 0h: Fixed weighted Average
 1h: Auto weighted Average
 2h: Reserved
 3h: Reserved

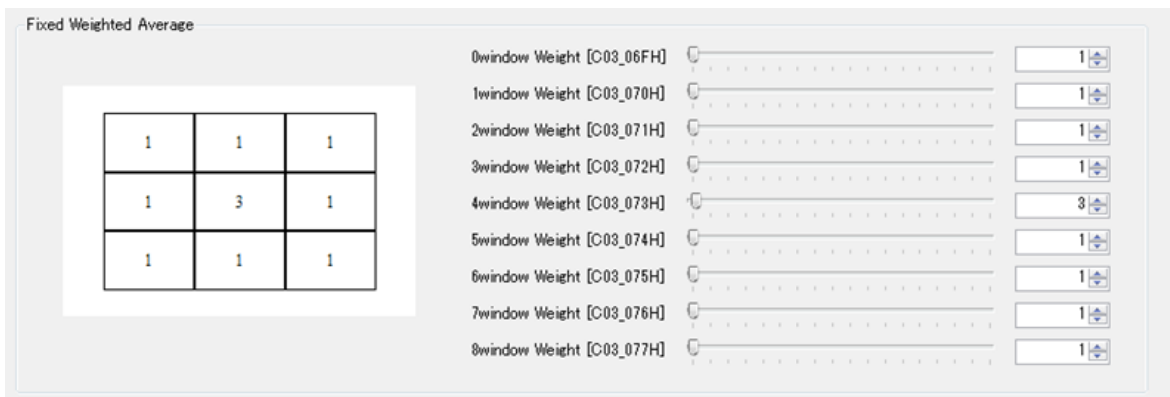

Fixed Weighted Average (WEIGHT0- WEIGHT8)

The fixed weighting mode works when the position of the subject to be shot is already known. There are nine detector frames, and a weighting can be set separately for each. By increasing the weighting of the frame where the subject to be shot is present, the exposure is controlled so that the brightness is just right for the subject.

Category: 03d

- 0 Window: WEIGHT0 Start byte: 06FH.0-7
- 1 Window: WEIGHT1 Start byte: 070H.0-7
- 2 Window: WEIGHT2 Start byte: 071H.0-7
- 3 Window: WEIGHT3 Start byte: 072H.0-7
- 4 Window: WEIGHT4 Start byte: 073H.0-7
- 5 Window: WEIGHT5 Start byte: 074H.0-7
- 6 Window: WEIGHT6 Start byte: 075H.0-7
- 7 Window: WEIGHT7 Start byte: 076H.0-7
- 8 Window: WEIGHT8 Start byte: 077H.0-7

Condition: [AEME](#) = 0 (0h) (AE mode), [BLCON](#) =1 (1h)
 Setting: 0 (0h) to 255 (FFh)

Selection:
 0[h] (minimum weighting) - FF[h] (maximum weighting)
 Correlation between frames and weighting parameters

Window 0	Window 1	Window 2
Window 3	Window 4	Window 5
Window 6	Window 7	Window 8

Auto Weighting mode

In the auto weighting mode, backlight compensation, which is not dependent on the position of the subject, can be implemented. The mode works when there is a difference in brightness between the background and subject to be shot.

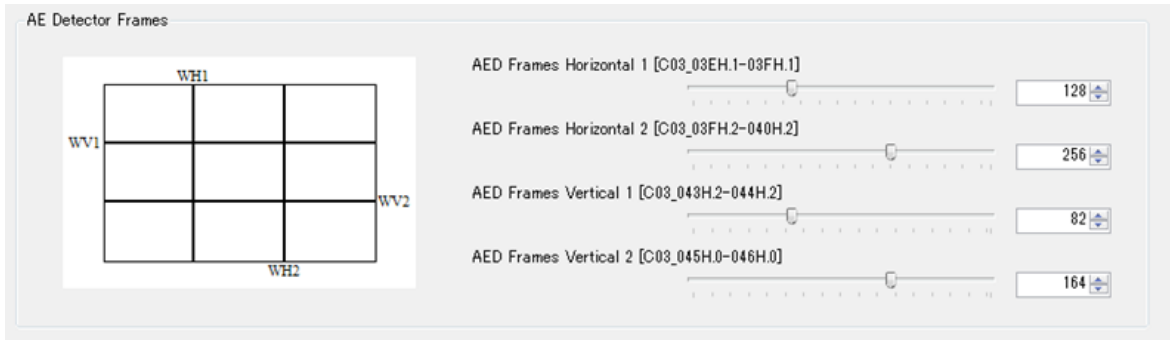

AE Detector Frames

Size of Auto Weight Window to be determined Horizontal: [AEDWH1](#), [AEDWH2](#) and Vertical: [AEDWV1](#), [AEDWV2](#).

AED Frame Horizontal 1,2 (AEDWH1, AEDWH2)

AEDWH1 : AED Frame Horizontal 1

AEDWH2 : AED Frame Horizontal 2

	AEDWH1,	AEDWH2
Outline	Sets the horizontal positions of the AED frames	
Category	03 d	
Start byte	03EH.1 to 03FH.1	03FH.2 to 040H.2
Setting	0 (0h) to 480 (1E0h) $1 \leq \text{AEDWH1} \leq$ Maximum horizontal value -2	0 (0h) to 480 (1E0h) $2 \leq \text{AEDWH2} \leq$ Maximum horizontal value -1
Selection	This sets the horizontal positions of the AED frames Increase or decrease 1 value, shift 2 pixels (2pixel/1[h])	

The maximum horizontal values differ depending on the CCD image sensor used.

AED Frame Vertical 1,2 (AEDWV1, AEDWV2)

AEDWV1: AED Frame Vertical 1

AEDWV2: AED Frame Vertical 2

	AEDWV1,	AEDWV2
Outline	Sets the vertical positions of the AED frames	
Category	03 d	
Start byte	043H.2 to 044H.2	045H.0 to 046H.0
Setting	0 (0h) to 290 (122h) $1 \leq \text{AEDWV1} \leq$ Maximum vertical value -2	0 (0h) to 290 (122h) $2 \leq \text{AEDWV2} \leq$ Maximum vertical value -1
Selection	This sets the vertical positions of the AED frames Increase or decrease 1 value, shift 2 lines (lines /1[h])	

The maximum vertical values differ depending on the CCD image sensor used.

AE Detector frame settings

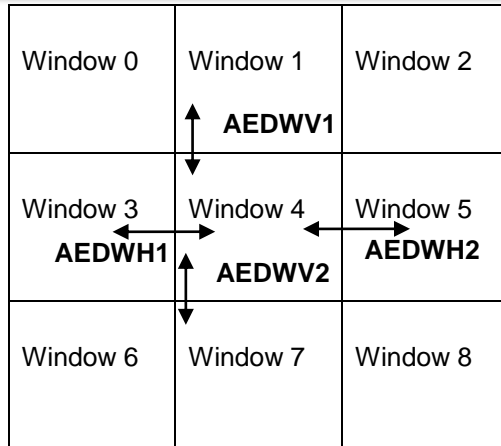

Set the parameters so that the following conditions are met.

$$AEDWH1 < AEDWH2$$

$$AEDWV1 < AEDWV2$$

Number of effective pixels per CCD device

	760H NTSC	760H PAL
Number of effective horizontal pixels	768	752
Number of effective vertical pixels	492	580

AE detector frame setting range

	760H NTSC	760H PAL
Minimum horizontal value (minimum value of AEDWH1)	1 (1h)	1(1h)
Maximum horizontal value (maximum value of AEDWH2)	383(18Fh)	375(177h)
Minimum vertical value (minimum value of AEDWV1)	1(1h)	1(1h)
Maximum vertical value (maximum value of AEDWV2)	245(F5h)	289(121h)

11.3.6 White Balance

AWB Mode (Auto White Balance Operation Mode (AWB))

Auto White Balance (AWB) is a function which compensates for deviations in the white color caused by changes in the color temperature of the light source to control the white balance gain within the chroma signal processing so that the colors are reproduced correctly. When the user sets this parameter through the Control Software (DQUCtrl), please turn off the Port Driver (For further information regarding the Port Driver, please refer to the Section [Port Driver Function](#)).

Category: 05 d

Start byte: 001H.0-3

Condition: -

Setting: 0 (0h) to 8 (8h)

Selection:

- 0h: ATW (Auto trace white balance)
- 1h: Full Pull IN
- 2h: Reserved
- 3h: Hold
- 4h: Reserved
- 5h: Reserved
- 6h: Reserved
- 7h: User
- 8h: Reserved

ATW (Auto trace white balance)

This function automatically tracks the changes in the color temperature, and adjusts the white balance. Pull-in control is exercised only when the color temperature is determined to be inside the pull-in frame.

Full Pull IN (Push to set white balance)

This function adjusts the white balance regardless of the subject conditions.

Pull-in control is exercised at all times independently of the pull-in frame which was set by the pre-white balance adjustment. This mode works faster than ATW mode.

Hold

In this mode, the colors are held using the gain values established immediately before control was set to the hold mode. A push-lock mode can be configured by using this function in combination with the Push mode. In this mode, operation is set to the hold mode after pull-in in the Push mode and the R and B gain values established at that point are written into the Flash ROM.

User

In this mode, fixed gain values [WBUSRR](#)(R gain for the user mode), [WBUSRB](#)(B gain for the user mode) are referred.

Manual White Balance (USER Mode)

R Gain Of USER Mode (WBUSRR)

Sets the R gain for the manual (user) white balance

Category: 05 d

Start byte: 013H.0-014H.3

Condition: [AWB](#) = 7 (7h): User

Setting: 0 (0h) to 4095 (FFh)

B Gain Of USER Mode (WBUSRB)

Sets the B gain for the manual (user) white balance

Category: 05 d

Start byte: 015H.0-016H.3

Condition: [AWB](#) = 7 (7h) : User

Setting: 0 (0h) to 4095 (FFFh)

11.3.7ME

ME Setting

Select AE/ME [C03_001H.0]	[00H]AE
Select ME Mode [C04_001H.0-1]	[00H]Shutter+AGC Manual
Port Driver Function(SW201_2-4)	[02H]ON
Manual Shutter Speed Select [C04_001H.2-4]	[00H]User Setting

Select AE/ME (AEME)

The AEME parameter is used to select auto exposure control (AE) or manual exposure control (ME).

Category: 03 d

Start byte: 001H.0

Condition: -

Setting: 0 (0h) to 1 (1h)

Selection:

0h: AE (Auto exposure)

1h: ME (Manual exposure)

Select ME Mode (MEMODE)

Selects the manual exposure control mode

AE mode has to be set as “Manual exposure (AEME = 1 (1h))” to activate this manual exposure control mode selection. With manual exposure (ME), users can set the shutter values including the low-speed shutter and AGC values as desired.

Category: 04 d

Start byte: 001H.0

Condition: [AEME](#) = 1 (1h) (ME mode)

Setting: 0 (0h) to 1 (1h)

Selection:

0h: Shutter + AGC Manual

1h: SLOW Shutter + AGC Manual

Manual Shutter Speed(MSHTSEL)

Select the preset exposure time.

When the user sets this parameter through the Control Software (DQUCtrl), please turn off the Port Driver (For further information regarding the Port Driver, please refer to the Section [Port Driver Function](#)).

Category: 04 d

Start byte: 001H.2-4

Condition: Port Driver Function (SW201_2-4) OFF, [Port Driver Function](#) (SW201.2-4) = “ON”

Setting: 0 (0h) to 7(7h)

Selection:

0h: User Setting

1h: 1/125

2h: 1/250

3h: 1/500

4h: 1/1000

5h: 1/2000

6h: 1/4000

7h: 1/10000

*Note: When 0h is selected, shutter speed value refer from electric shutter value of NSUB,TREAD.

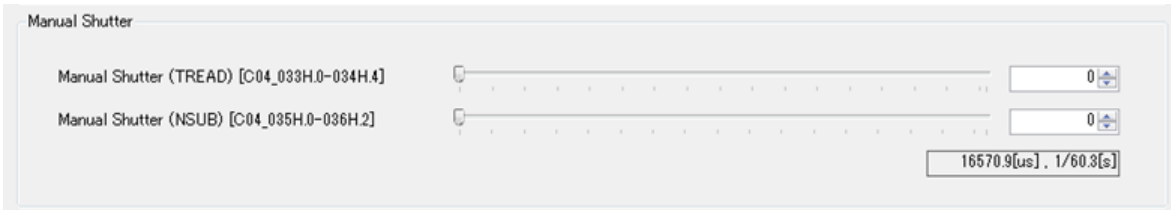

Manual Shutter (TREAD)

Electronic shutter preset setting

Category: 04 d
 Start byte: 033H.0-034H.4
 Condition: [MEMODE](#) = 0 (0h)
 Setting: 0 (0h) to 1151 (47Fh)

Manual Shutter (NSUB)

Electronic shutter preset setting

Category: 04 d
 Start byte: 035H.0-036H.2
 Condition: [MEMODE](#) = 0 (0h)
 Setting: 0 (0h) to 311 (137h)

Electronic shutter exposure time calculation formula

nsub: NSUB tread: TREAD

The formulas for calculating the electronic shutter exposure times are listed in the table below. The electronic shutter exposure time extends from the SUB pulse applied last during one VD period to the read pulses.

"nsub" in the table below indicate the SUB pulse; "tread" indicates the read pulse.

The SUB pulse is set in HD increments and the higher the value, the shorter the exposure time.

The read pulse is set in clock increments and the higher the value, the longer the exposure time.

CCD Type		Exposure time
1/3" 1/2"	NTSC	$(261 - \text{nsub}) * 63.49\mu\text{s} + (\text{tread} * 69.84\text{ns})$ Setting range: nsub=0-261, tread=0-909 But when nsub = 0, then tread = 0 when nsub = 261, then tread = 143-909
	PAL	$(311 - \text{nsub}) * 64.00\mu\text{s} + (\text{tread} * 70.48\text{ns})$ Setting range: nsub=0-311, tread=0-907 But when nsub = 0, then tread = 0 when nsub = 311, then tread=142-907

#Example

1/100 sec exposure on NTSC : nsub = 104, tread = 459

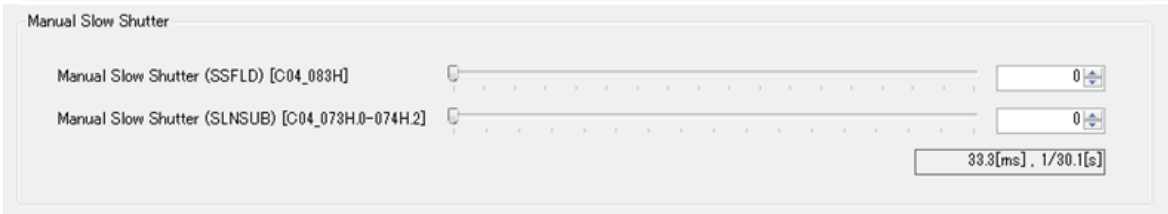

Manual Slow Shutter (SSFLD)

Electronic shutter preset setting

Category: 04 d
 Start byte: 083H.0-7
 Condition: [MEMODE](#) = 1 (1h)
 Setting: 0 (0h) to 255 (FFh)
 Selection:

Manual Slow Shutter (SLNSUB)

Electronic shutter preset setting

Category: 04 d
 Start byte: 073H.0-074H.2
 Condition: [MEMODE](#) = 1 (1h)
 Setting: 0 (0h) to 624 (270h)
 Selection:

Low-speed shutter exposure time calculation formulas

ssfld : SSFLD
 nsub : SLNSUB

With the low-speed shutter settings, the formula used to calculate the exposure time differs from one CCD type to another. The higher the "nsub" value, the shorter the exposure time in HD increments. Furthermore, the higher the "ssfld" value, the longer the exposure time in 2-field increments.

CCD Type		Exposure time
1/3" 1/2"	NTSC	$(524 - nsub) * 63.49us + (((ssfld + 1) * 2) - 2) *$ 16,634us Setting range: nsub=0-524, ssfld=0-255 But when ssfld=0, setting nsub=524 is prohibited.
	PAL	$(624 - nsub) * 64.00us + (((ssfld + 1) * 2) - 2) *$ 19,968us Setting range: nsub=0-624, ssfld=0-255 But when ssfld=0, setting nsub=624 is prohibited.

#Example

1/2 sec exposure on NTSC : nsub = 508, ssfld = 15 => 500ms



Manual AFE Gain (APGA)

VGA (Variable Gain Amp) preset setting for AFE
 Selects the ME control mode. Work on AEME =1.
 AFE gain (analog gain)

Category: 04 d
 Start byte: 003H.0-004H.2
 Condition: [AEME](#) = 1 (1h) (ME mode)
 Setting: 0 (0h) to 1580 (62Ch)
 Selection:
 Gain value [dB] = (APGA parameter value * 0.0342) - 6

AFE VGA (Variable gain amp) value calculation formula

The formula for calculating the VGA value of this camera is shown below.

<Parameters supported>
 APGA parameters : APGA
 Gain value [dB] = (APGA parameter value * 0.0342) - 6

The setting ranges of the APGA parameters (APGA) differ depending on the DPGA value as shown in "APGA parameter setting range" as shown in the table below.
 The DPGA value is determined solely by the saturation signal volume of the CCD image sensor used.

APGA parameter setting range:

DPGA (CAT13_Byte42_bit3-4)	APGA Setting range	Gain range supported
0	0[h] - 524[h]	-6[dB] - 57[dB]
1	58[h] - 57C[h]	-3[dB] - 42[dB]
2	B0[h] - 5D4[h]	0[dB] - 45[dB]
3	108[h] - 62C[h]	3[dB] - 48[dB]

Correlation between APGA setting values and gain values

The figure below shows the correlation between the parameter setting values and the gain values

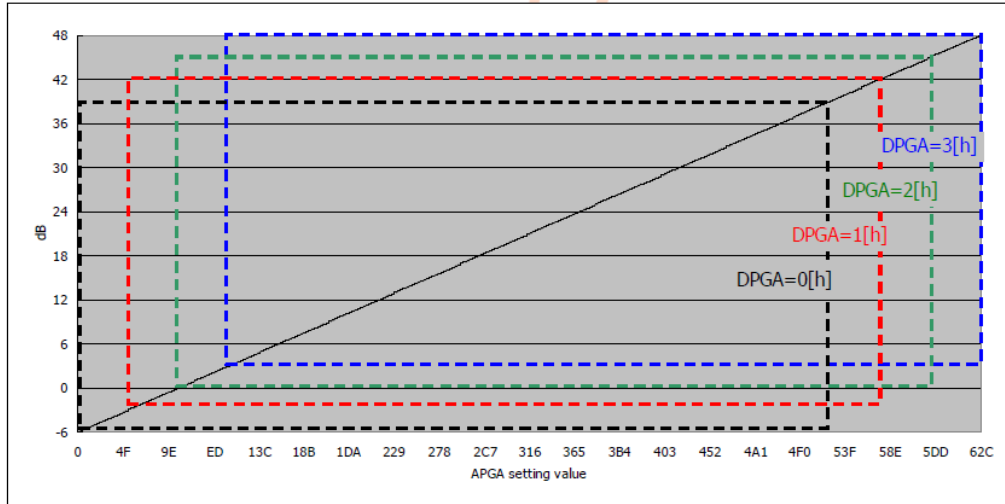

11.3.8Aperture

This function compensates the edges to increase the image resolution as it appears. The edge enhancement level is adjusted by setting the gain. System enables the horizontal and vertical aperture compensation to be set separately. VH aperture compensation for adjusting the overall aperture compensation gain is also available. To increase the resolution as it appears and enhance the edges, select high settings for the gain values. However, bear in mind that ringing will become more noticeable when the gain values are set too high.

Horizontal Aperture Compensation

H Aperture Compensation High Frequency Gain [C02_055H.0-1]

H Aperture Compensation Low Frequency Gain [C02_055H.2-3]

H Aperture Compensation High Frequency Gain(HAPGH)

Sets the high-range gain for horizontal aperture compensation

- Category: 02 d
- Start byte: 055 H.0- 1
- Condition: -
- Setting: 0 (0h) to 3(3h)
- Selection:
 - 0h : x0
 - 1h : x1
 - 2h : x2
 - 3h : x4

H Aperture Compensation Low Frequency Gain(HAPGL)

Sets the low-range gain for horizontal aperture compensation

- Category: 02 d
- Start byte: 055 H.2- 3
- Condition: -
- Setting: 0 (0h) to 3(3h)
- Selection:
 - 0h : x0
 - 1h : x0.5
 - 2h : x1
 - 3h : x2

The slice function in vertical aperture compensation and VH aperture compensation is used to eliminatethe noise components which have been emphasized by the gain. When the slice level is increased, the noise is more readily eliminated but the resolution as it appears will deteriorate.

Vertical Aperture Compensation

V Aperture Compensation Gain [C02_055H.4-7]

V Aperture Compensation Slice Level [C02_056H.0-2]

V Aperture Compensation Gain(VAPG)

Sets the vertical aperture compensation gain

Category: 02 d

Start byte: 055 H.4- 7

Condition: -

Setting: 0 (0h) to 15(Fh) (x0 to x1)

V Aperture Compensation Slice Level(VAPSL)

Sets the slice level for the vertical aperture compensation

Category: 02 d

Start byte: 056 H.0- 2

Condition: -

Setting: 0 (0h) to 7(7h) (slice level 0 - slice level max.)

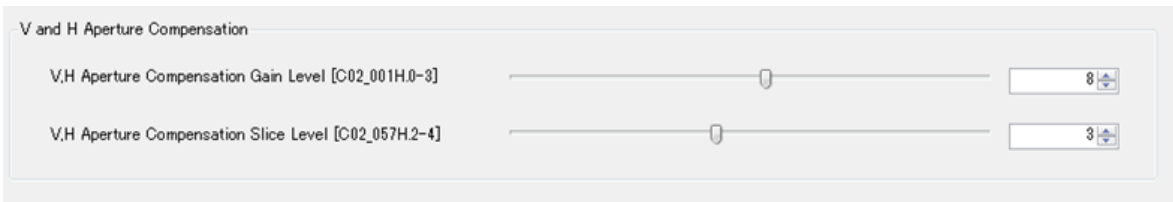

V,H Aperture Compensation Gain Level(VHAPG)

Sets the gain level after adding the V and H aperture compensation values

Category: 02 d

Start byte: 001 H.0- 3

Condition: -

Setting: 0 (0h) to 15(Fh) (x0 to x2)

V,H Aperture Compensation Slice Level(VHAPSL)

Sets the slice level after VH aperture compensation+

Category: 02 d

Start byte: 057 H.2- 4

Condition: -

Setting: 0 (0h) to 7(7h) (slice level 0 - slice level max.)

11.3.9Other

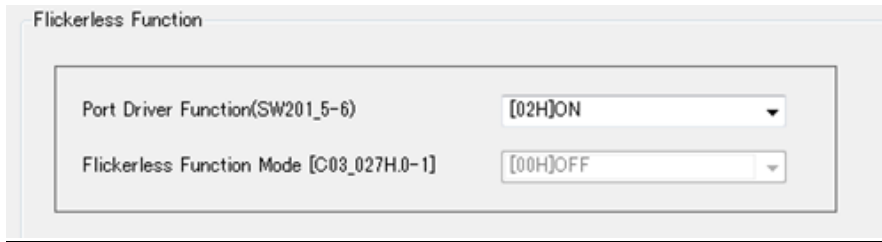

Flickerless Function

Flicker occurs across the entire screen when subjects have been shot under conditions where the flashing periods for fluorescent lighting differ from the electronic shutter exposure times. This camera has two modes to deal with flicker; fixed shutter mode for fixing the electronic shutter value to the flashing period of the flicker, and the gain modulation mode for modulating the PGA value to the flashing period of the flicker.

Flickerless Function Mode(FLCMODE)

Selects the flicker-less mode for the AE and WDR long-time exposure side

When the user sets this parameter through the Control Software (DQUCtrl), please turn off the Port Driver (For further information regarding the Port Driver Function, please refer to the Section [Port Driver Function](#)).

Category: 03 d

Start byte: 027 H.0- 1

Condition: [AEME](#) =0[h], [Port Driver Function](#) (SW201.5-6) = "ON"

Setting: 0 (0h) to 2(2h)

Selection:

- 0h : OFF
- 1h : Shutter Speed Fixed
- 2h : PGA Gain Control

Shutter Speed Fixed

In this mode, the electronic shutter speed is fixed to 1/100 (NTSC) or 1/120 (PAL) of the flashing period of the fluorescent lighting to minimize the flicker. In addition, if the 2 [h] fixed shutter mode has been selected as the AEMODE setting, the AE fixed shutter value takes precedence.

PGA Gain Control

The gain modulation mode makes use of the fact that the flashing of the flicker changes cyclically to control the digital gain inside the DSP to minimize the flicker.

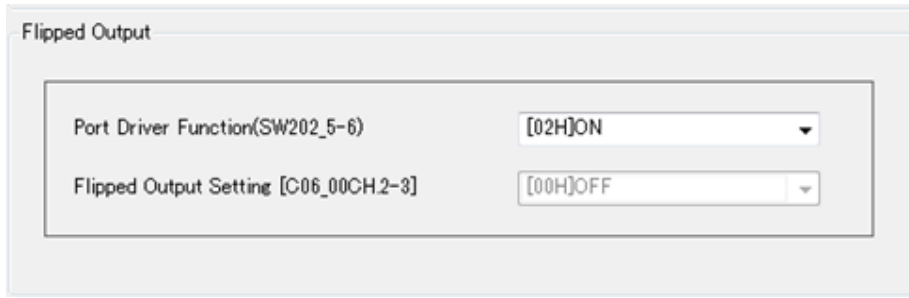

Flipped Output Setting(MCOFLIPA)

The flip function enables the analog output or digital output of images whose top/bottom or left/right have been reversed or which have been rotated by 180 degrees.

When the user sets this parameter through the Control Software (DQUCtrl), please turn off the Port Driver (For further information regarding the Port Driver, please refer to the Section [Port Driver Function](#)).

Category: 06 d

Start byte: 00C H.2- 3

Condition: -

Setting: 0 (0h) to 3(3h)

Selection:

- 0h: OFF (no flipping)
- 1h: Up/Down inversion
- 2h: Right/Left inversion
- 3h: 180 Degrees Rotation

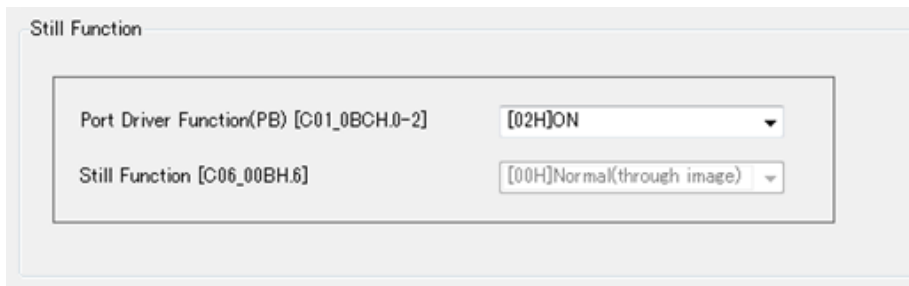

Still Function(MCOMODEA)

The still function freezes the frames of moving images which are being shot. The image applying when the MCOMODEA parameter was set to 1[h] is freeze-framed. The electronic zoom or flip function can be applied to freeze-framed images.

When the user sets this parameter through the Control Software (DQUCtrl), please turn off the Port Driver (For further information regarding the Port Driver, please refer to the Section [Port Driver Function](#)).

Category: 06 d

Start byte: 00B H.6

Condition: -

Setting: 0 (0h) to 1(1h)

Selection:

0h: Normal

1h: Still

12 Revisions

Rev.	Date	Changes	Note
0.01	2014/05/13	New Document	
0.02	07/10/2014	Edited Document English translation edit	RM
0.03	1/7/2015	Removed TBDs from Specifications	

Sensor Technologies America, Inc.

1345 Valwood Pkwy, Suite 320

Carrollton, TX 75006

TEL: (972)-481-9223

FAX: (972)-481-9209

www.SentechAmerica.com

Sentech Co., Ltd.

7F, Harada center building

9-17, Naka cho 4 chome

Atsugi-city, Kanagawa

243-0018 Japan

TEL 81-46-295-7061 FAX 81-46-295-7066

URL <http://www.sentech.co.jp/>