

DINION IP dynamic 7000 KIT

www.boschsecurity.com



BOSCH
Invented for life



- ▶ Stylish and sturdy housing (IP66; NEMA 4x)
- ▶ Built-in Intelligent Video Analysis to trigger relevant alerts and quickly retrieve data
- ▶ High Dynamic Range to see details in bright and dark areas simultaneously (106 dB with IAE)
- ▶ Intelligent noise reduction reduces bandwidth and storage requirements by up to 50%
- ▶ Auto back focus for fast installation

These pre-packaged camera kits are complete surveillance systems that are quick and easy to install thanks to their plug-and-play design. Each kit includes a housing with a factory-installed high-performance DINION camera and varifocal lens, plus a swivel mount.

The DINION IP dynamic 7000 HD camera is a 1080p30 progressive scan CMOS camera that uses Bosch-designed digital imaging technology to achieve a very high dynamic range.

The camera uses an internal feedback system based on the intelligent analysis of the scene, to re-tune the video processing. This provides better detail in the areas that matter and better all-round performance, day or night. Features such as multicasting, internet streaming and iSCSI recording are fully supported.

System overview

High Dynamic Range

The High Dynamic Range (HDR) of the camera means that you can view details in the bright and the dark areas of a scene at the same time. HDR is based on a dual exposure process that captures more details in highlights and shadows even under challenging lighting conditions. The result is that you can distinguish objects and features easily.

Hybrid operation

A surge-protected analog video output allows full hybrid operation. This means that high resolution IP video streaming and an analog video output are available simultaneously. The hybrid functionality offers an easy migration path from legacy CCTV to a modern IP-based system.

Functions

Secure and easily-installed

The sleek and sturdy housing design meets IP66 and NEMA 4X enclosure standards to protect your video surveillance equipment from adverse elements. A built-in heater and fan keep the internal temperature of the housing within the specified operating temperatures. A permanent low-power window defroster keeps the housing window clear in high humidity and icy condition. A sunshield is fitted to the top of the housing. Tamper-resistant screws for the locking clasps prevent illegitimate access to the housing contents. The supplied mounting bracket has a swivel and tilt head for maximum mounting flexibility. User connections for power, ethernet and/or telemetry can be routed through seal-tight fittings in the rear or in the foot of the housing.

The unique, hinged, side-opening design in the housing provides easy access to the camera/lens controls when the kit is mounted. The auto-focus lens wizard makes it easy for an installer to accurately focus the camera for both day and night operation. The wizard is activated from the web browser or from the on-board camera push button making it easy to choose the workflow that suits best. The automatic motorized back focus adjustment with 1:1 pixel mapping ensures the camera is always focused accurately.

Power failover

To increase power reliability, the camera can be simultaneously connected to both Power-over-Ethernet (PoE) and the housing power supply. If the housing power supply fails and PoE is available, the camera switches seamlessly to the PoE power input. This ensures the camera remains operational during a local power supply failure. After the housing power supply is restored, the camera switches back to the housing power input.

Pre-wired

For easy connection, some kit models have a 1.5 m (5 ft) power cable pre-wired through a seal-tight cable gland in the housing foot. An ethernet cable and other cables can be later fed through a second fitting in the foot, or through fittings in the rear of the housing.

Content Based Imaging Technology

Content Based Imaging Technology (CBIT) is used to radically improve image quality in all lighting conditions and to identify areas for enhanced processing. The camera examines the scene using Intelligent Video Analysis (IVA) and provides feedback to re-tune the image processing. This provides better detail in the areas that matter and better all-round performance. With IVA, the Intelligent Auto Exposure technology, for example, allows you to view moving objects in bright and dark areas of a scene.

Intelligent Dynamic Noise Reduction reduces bandwidth and storage requirements

The camera uses Intelligent Dynamic Noise Reduction which actively analyzes the contents of a scene and reduces noise artifacts accordingly.

The low-noise image and the efficient H.264 compression technology provide clear images while reducing bandwidth and storage by up to 50% compared to other H.264 cameras. This results in reduced-bandwidth streams that still retain a high image quality and smooth motion. The camera provides the most usable image possible by cleverly optimizing the detail-to-bandwidth ratio.

Area-based encoding

Area-based encoding is another feature which reduces bandwidth. Compression parameters for up to eight user-definable regions can be set. This allows uninteresting regions to be highly compressed, leaving more bandwidth for important parts of the scene.

The average typical optimized bandwidth in kbits/s for various image rates is shown in the table:

IPS	1080p	720p	480p
30	1600	1200	600
15	1274	955	478
12	1169	877	438
5	757	568	284
2	326	245	122

Multiple streams

The innovative multi-streaming feature delivers various H.264 streams together with an M-JPEG stream. These streams facilitate bandwidth-efficient viewing and recording as well as integration with third-party video management systems.

An upright mode can be selected for the second stream. In this mode an image of 400 x 720 (9:16 aspect ratio) is cropped from the full sensor image. When the scene to be monitored is suitable to this mode, the bandwidth and storage requirements are reduced.

Regions of interest and E-PTZ

Regions of Interest (ROI) can be user defined. The remote E-PTZ (Electronic Pan, Tilt and Zoom) controls allow you to select specific areas of the parent image. These regions produce separate streams for remote viewing and recording. These streams, together with the main stream, allow the operator to separately monitor the most interesting part of a scene while still retaining situational awareness.

With IVA, Intelligent Tracking can follow objects within the defined regions of interest. Intelligent Tracking can autonomously detect and track moving objects or the user can click on an object which the tracker will then follow.

Simple set-up

The camera has a very intuitive user interface that allows fast and easy configuration. Six configurable user modes are provided with the best settings for a variety of applications:

- **Indoor** – general day-to-night changes without sun highlights and street lighting
- **Outdoor** – general day-to-night changes with sun highlights and street lighting
- **Motion** – monitoring traffic or fast moving objects; motion artifacts are minimized
- **Lowlight** – optimized for sufficient details at low light.
- **Intelligent AE** – for people moving in front of a bright background
- **Vibrant** – enhanced contrast, sharpness and saturation

Storage management

Recording management can be controlled by the Bosch Video Recording Manager (VRM) or the camera can use iSCSI targets directly without any recording software.

Edge recording

The MicroSD card slot supports up to 2 TB of storage capacity. A microSD card can be used for local alarm recording. Pre-alarm recording in RAM reduces recording bandwidth on the network, or – if microSD card recording is used – extends the effective life of the storage medium.

Video analytics

With built-in video content analysis, the camera reinforces the Intelligence-at-the-Edge concept where edge devices become increasingly intelligent. The MOTION+ video motion analysis system that is built into all camera versions is the perfect solution for applications where standard video content analysis features are required.

The IVA version of the camera uses the latest generation of the Bosch Intelligent Video Analysis (IVA) software. This IVA system is the guard-assistant system of choice when reliable indoor or outdoor video analytics is needed. The state-of-the-art system reliably detects, tracks, and analyzes moving objects while suppressing unwanted alarms from spurious sources in the image.

The face detection feature detects faces in the scene and forwards a high quality JPEG image of the best shot of each face when the face disappears from the scene.

Retrospective forensic search capabilities are available remotely from the web browser or the Bosch Video Client.

Cloud-based services

The camera supports time-based or alarm-based JPEG posting to four different accounts. These accounts can address FTP servers or cloud-based storage facilities (for example, Dropbox). Video clips or JPEG images can also be exported to these accounts.

Alarms can be set up to trigger an e-mail or SMS notification so you are always aware of abnormal events.

Access security

Password protection with three levels and 802.1x authentication is supported. To secure Web browser access, use HTTPS with a SSL certificate stored in the camera. The video and audio communication channels can be independently AES encrypted with 128-bit keys by installing the optional encryption site license.

Complete viewing software

There are many ways to access the camera's features: using a web browser, with the Bosch Video Management System, with the free-of-charge Bosch Video Client, with the video security mobile app, or via third-party software.

Video security App

The Bosch video security mobile App has been developed to enable **Anywhere** access to HD surveillance images allowing you to view live images from any location. The App is designed to give you complete control of all your cameras, from panning and tilting to zoom and focus functions. It's like taking your control room with you.

This App, together with the separately available Bosch transcoder, will allow you to fully utilize our dynamic transcoding features so you can play back images even over low-bandwidth connections.

System integration

The camera conforms to the ONVIF Profile S specification. Compliance with this standard guarantees interoperability between network video products regardless of manufacturer.

Third-party integrators can easily access the internal feature set of the camera for integration into large projects. Visit the Bosch Integration Partner Program (IPP) website (ipp.boschsecurity.com) for more information.

True day/night switching

The camera incorporates mechanical filter technology for vivid daytime color and exceptional night-time imaging while maintaining sharp focus under all lighting conditions.

Typical applications

- Tunnels – viewing details in bright and dark areas
- Entrances and exits – identification with strong backlight
- Traffic – capturing moving vehicles at night

Lens options

Two super resolution megapixel lens versions are available for the housing kits:

- One with a 9-40 mm IR-corrected varifocal lens
- One with a 3.8-13 mm varifocal lens

Certifications and approvals**HD standards**

Complies with the SMPTE 274M-2008 Standard in:

- Resolution: 1920x1080
- Scan: Progressive
- Color representation: complies with ITU-R BT.709
- Aspect ratio: 16:9
- Frame rate: 25 and 30 frames/s

Complies with the SMPTE 296M-2001 Standard in:

- Resolution: 1280x720
- Scan: Progressive
- Color representation: complies with ITU-R BT.709
- Aspect ratio: 16:9
- Frame rate: 25 and 30 frames/s

Standards

Emission	EN55022 Class B FCC Part 15, class B
----------	---

Immunity	EN50130-4 (PoE, +12 VDC, 24 VAC)* EN50121-4
Safety	EN60950-1 UL60950-1 (2nd edition) CAN/CSA-C 22.2 No. 60950-1
Vibration	Camera with lens as per IEC60068-2-6 (5 m/s ² , operational)
ONVIF conformance	EN 50132-5-2; IEC 62676-2-3

* Chapters 7 and 8 (mains voltage supply requirement) are not applicable to the camera. However, if the system in which this camera is used needs to comply with this standard, then any power supplies used must comply with this standard.

Marks	CE, cULus, WEEE, PADS, RCM and China RoHS
-------	---

Region	Certification
Europe	CE
USA	UL
Canada	ULC

Installation/configuration notes

Housing dimensions

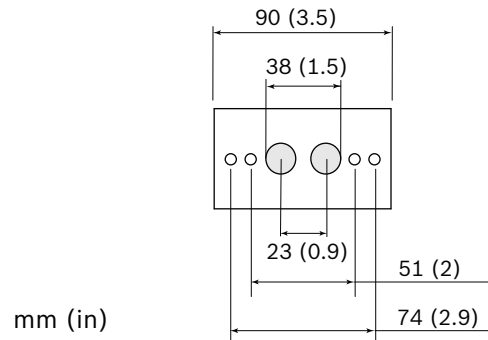
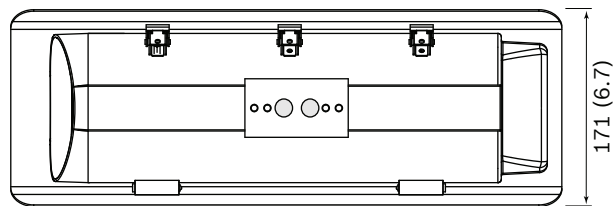
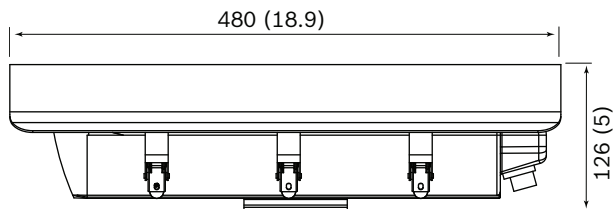

mm (in)

Mount dimensions

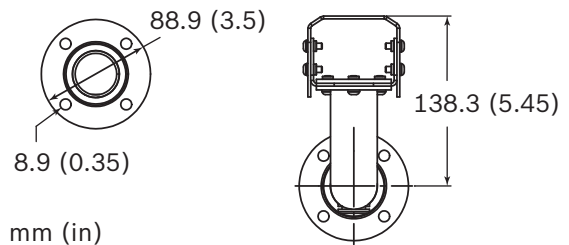
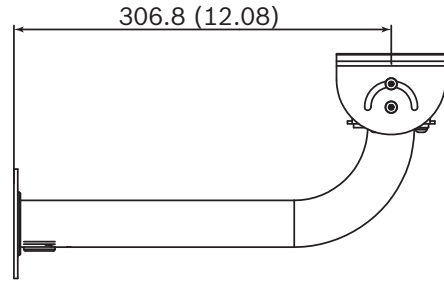
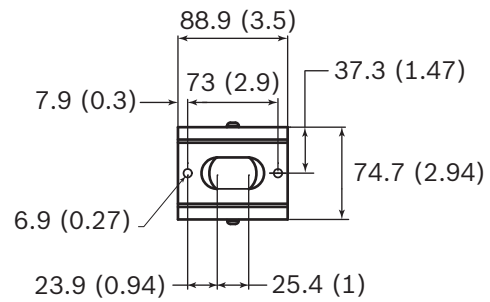

mm (in)

Controls

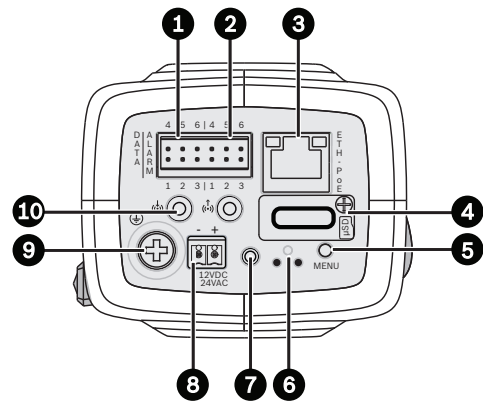

1	Data (RS485/422/232)	6	Reset button
2	Alarm in, relay out	7	Video out
3	10/100 Base-T Fast Ethernet	8	Power supply input
4	MicroSD card slot	9	Earth
5	Menu button	10	Audio in / Audio out

Parts included

	Item
1x	Housing (including built-in camera and lens, sunshield, heater and blower)
1x	Wall mount
1x	Documentation set
1x	Cable mounting package
1x	Identification labels

Technical specifications**Housing****Mechanical**

Dimensions (H x W x L) - closed and including sunshield	126.5 x 171.3 x 480 mm (5 x 6.7 x 18.9 in.)
Weight (including camera and lens)	3.9 kg (8.6 lbs)
Construction	Aluminum casing, neoprene gaskets, all stainless steel hardware, 3.3 mm (1/8 in.) thick glass window
Color	Gray
Locking clasps (3x)	Tamper-resistant screws provided
Camera mounting	Removable camera/lens tray, mounted with two screws
Max camera + lens size (H x W x L)	91 x 81 x 262 mm (3.6 x 3.2 x 10.3 in)
Mounting	2 x pair of tapped holes (1/4-20 thread) <ul style="list-style-type: none"> inner pair: 50.8 mm (2.0 in) center spread outer pair: 73.7 mm (2.9 in) center spread
Rear fittings (-20N models)	1x cable diameter: 3.5 to 8.0 mm (0.14 to 0.32 in) 2x cable diameter: 5.8 to 10 mm (0.23 to 0.39 in)
Rear connectors (-10N models)	1x M20: 3.5 to 8.0 mm (0.14 to 0.32 in) 1x 4-pin (power) 1x BNC (hybrid analog video)
Bottom fittings (-20N models)	2x cable diameter: 4.5 to 7.9 mm (0.18 to 0.31 in)

Power

Power input	24 VAC
Consumption	45 W
Fuse	4 A

Environmental

Operating temperature	-40°C to +50°C (-40°F to 122°F) for continuous operation; -34 °C to +74 °C (-30 °F to +165 °F) according to NEMA TS 2-2003 (R2008), para 2.1.5.1 using fig. 2.1 test profile
Storage temperature	-40°C to +70°C (-40°F to +158°F)
Operating humidity	20% to 93% RH
Storage humidity	up to 98% RH
Enclosure protection	IP66, NEMA 4X

Camera**Power**

Power Supply	24 VAC 50/60 Hz 12 VDC Power-over-Ethernet 48 VDC nominal
Current Consumption	500 mA (12 VDC) 450 mA (24 VAC) 175 mA (PoE 48 VDC)
Power Consumption	6 W (12 VDC) 10.8 W (24 VAC) 8.4 W (PoE 48 VDC)
PoE	IEEE 802.3af (802.3at Type 1)

Sensor

Type	1/3-inch CMOS
Pixels	2048 x 1536 (3MP)

Video performance

Sensitivity – (3200K, reflectivity 89%, F1.2, 30IRE)	
• Color	0.25 lx (0.025 fc)
• Mono	0.08 lx (0.008 fc)
Dynamic range	90 dB High Dynamic Range (HDR) 106 dB HDR (with IAE)

Video streaming

Video compression	H.264 (MP); M-JPEG
Streaming	Multiple configurable streams in H.264 and M-JPEG, configurable frame rate and bandwidth. Regions of Interest (ROI)
Overall IP Delay	Min. 120 ms, Max. 240 ms
GOP structure	IP, IBP, IBBP
Encoding interval	1 to 30 (25) ips
Resolutions (H x V)	
• 1080p HD	1920 x 1080

Video streaming	
• 960p HD 4:3 (cropped)	1280 x 960
• 720p HD	1280 x 720
• Upright 9:16 (cropped)	400 x 720
• D1 4:3 (cropped)	704 x 480
• 480p SD	Encoding: 704 x 480; Displayed: 854 x 480
• 432p SD	768 x 432
• 288p SD	512 x 288
• 240p SD	Encoding: 352 x 240; Displayed: 432 x 240
• 144p SD	256 x 144

Video functions	
Day/Night	Color, Mono, Auto
Adjustable picture settings	Contrast, Saturation, Brightness
White Balance	4 automatic modes, manual mode and measure
Shutter	Automatic Electronic Shutter (AES) Fixed (1/30 [1/25] to 1/15000) selectable Default shutter
High dynamic range	On/off
Backlight compensation	Off / On / Intelligent Auto Exposure
Contrast enhancement	On/off
Noise reduction	Intelligent Dynamic Noise Reduction with separate temporal and spatial adjustments
Sharpness	Sharpness enhancement level selectable
Intelligent defog	Intelligent Defog automatically adjusts parameters for best picture in foggy or misty scenes (switchable)
Privacy Masking	Four independent areas, fully programmable
Video Motion Analysis	Intelligent Video Analysis
Other functions	Image mirror, Image flip, Pixel counter, Video watermarking, Display stamping, Scene modes

Audio streaming	
Audio Streaming	Full duplex / half duplex
Signal-to-noise ratio	> 50 dB
Audio compression	AAC-LC, G.711, L16 (live and recording)

Local storage	
Internal RAM	10 s pre-alarm recording
Memory card slot	Supports up to 32 GB SDHC / 2 TB SDXC card. (An SD card of Class 6 or higher is recommended for HD recording)
Recording	Continuous recording, ring recording, alarm/ events/schedule recording

Network	
Protocols	IPv4, IPv6, UDP, TCP, HTTP, HTTPS, RTP/ RTCP, IGMP V2/V3, ICMP, ICMPv6, RTSP, FTP, Telnet, ARP, DHCP, APIPA (Auto-IP, link local address), NTP (SNTP), SNMP (V1, MIB-II), 802.1x, DNS, DNSv6, DDNS (DynDNS.org, selfHOST.de, no-ip.com), SMTP, iSCSI, UPnP (SSDP), DiffServ (QoS), LLDP, SOAP, Dropbox, CHAP, digest authentication
Encryption	TLS 1.0, SSL, DES, 3DES
Ethernet	10/100 Base-T, auto-sensing, half/full duplex
Connectivity	ONVIF Profile S, Auto-MDIX

Software	
Unit Configuration	Via web browser or Configuration Manager
Firmware update	Remotely programmable
Software viewer	Web browser, Bosch Video Client, or third party software

Input/output	
Analog video out	CVBS (PAL/NTSC), 1 Vpp, SMB, 75 Ohm (surge protected)
Analog video aspect ratio	4:3 letterbox, 4:3 cropped, or 16:9 mode
Audio	1 x mono line in, 1 x mono line out
• connector	3.5 mm stereo jack
• signal line in	12 kOhm typical, 1 Vrms max
• signal line out	1 Vrms at 1.5 kOhm typical,
Alarm	2 inputs
• connector	Clamp (non-isolated closing contact)

Input/output	
• activation voltage	+5 VDC to +40 VDC (+3.3 VDC with DC-coupled 22 kOhm pull-up resistor)
Relay	1 output
• connector	Clamp
• voltage	30 VAC or +40 VDC Maximum 0.5 A continuous, 10VA
Data port	RS-232/422/485

Optical	
Lens mount	CS mount (C-mount with adapter ring)
Lens connector	Standard 4-pin DC-iris connector
Focus control	Motorized back-focus adjustment
Lens Controls	Wizard from web page or camera button
Iris control	Automatic iris control

Lens

LVF-5003N-S3813 Varifocal SR Megapixel Lens

Focal length	3.8 – 13 mm
Iris range	F1.4 to F8
Min object distance	0.3 m (1 ft)
1/3-inch sensor 16:9 Angle of view (HxV)	79 x 43° Wide 23 x 13° Tele
Focus control	manual
Zoom control	manual
IR corrected	IR performance (not with IR illuminator)

LVF-5005C-S0940 Varifocal SR Megapixel Lens

Focal length	9 – 40 mm
Iris range	F1.5 to F8
Min object distance	2.5 m (9.2 ft)
1/3-inch sensor 16:9 Angle of view (HxV)	33 x 17° Wide 7.7 x 4.4° Tele
Focus control	manual
Zoom control	manual
IR corrected	yes

Mount

Mount LTC 9215/00

Length	300 mm (12 in)
Maximum Load	9 kg (20 lb)

Mount LTC 9215/00

Mounting Head	Adjustable 360° pan, 180° tilt
Finish	Light gray
Approx. Weight	0.4 kg (0.9 lb)
Mounting	2 x tapped holes Thread: 1/4-20 73.7 mm (2.9 in) center spread

Ordering information

DINION IP dynamic 7000 KIT

High dynamic IP camera and lens in 24 VAC (60 Hz) housing kit. IP66; NEMA 4X; hybrid IP/Analog; HDR; 1080p30; PoE; IDNR; IAE; ROI; IVA; H.264 quad-streaming; free viewing apps; cloud services; audio/motion detection; 9-40 mm lens
Order number **NKN-71027-BA4-10N**

DINION IP dynamic 7000 KIT

High dynamic IP camera and lens in 24 VAC (60 Hz) housing kit. IP66; NEMA 4X; hybrid IP/Analog; HDR; 1080p30; PoE; IDNR; IAE; ROI; IVA; H.264 quad-streaming; free viewing apps; cloud services; audio/motion detection; 3.8-13 mm lens
Order number **NKN-71027-BA3-10N**

DINION IP dynamic 7000 KIT

High dynamic IP camera and lens in 24 VAC (60 Hz) housing kit. IP66; NEMA 4X; hybrid IP/Analog; HDR; 1080p30; PoE; IDNR; IAE; ROI; IVA; H.264 quad-streaming; free viewing apps; cloud services; audio/motion detection; 9-40 mm lens; pre-wired
Order number **NKN-71027-BA4-20N**

DINION IP dynamic 7000 KIT

High dynamic IP camera and lens in 24 VAC (60 Hz) housing kit. IP66; NEMA 4X; hybrid IP/Analog; HDR; 1080p30; PoE; IDNR; IAE; ROI; IVA; H.264 quad-streaming; free viewing apps; cloud services; audio/motion detection; 3.8-13 mm lens; pre-wired
Order number **NKN-71027-BA3-20N**

Accessories

Monitor/DVR Cable SMB 0.3M

0.3 m (1 ft) analog cable, SMB (female) to BNC (female) to connect camera to coaxial cable
Order number **NBN-MCSMB-03M**

Represented by:

Americas:

Bosch Security Systems, Inc.
130 Perinton Parkway
Fairport, New York, 14450, USA
Phone: +1 800 289 0096
Fax: +1 585 223 9180
security.sales@us.bosch.com
www.boschsecurity.us

Europe, Middle East, Africa:

Bosch Security Systems B.V.
P.O. Box 80002
5617 BA Eindhoven, The Netherlands
Phone: + 31 40 2577 284
Fax: +31 40 2577 330
emea.securitysystems@bosch.com
www.boschsecurity.com

Asia-Pacific:

Robert Bosch (SEA) Pte Ltd, Security
Systems
11 Bishan Street 21
Singapore 573943
Phone: +65 6571 2808
Fax: +65 6571 2699
apr.securitysystems@bosch.com
www.boschsecurity.asia

China:

Bosch (Shanghai) Security Systems Ltd.
203 Building, No. 333 Fuquan Road
North IBP
Changning District, Shanghai
200335 China
Phone +86 21 22181111
Fax: +86 21 22182398
www.boschsecurity.com.cn

America Latina:

Robert Bosch Ltda Security Systems Division
Via Anhanguera, Km 98
CEP 13065-900
Campinas, Sao Paulo, Brazil
Phone: +55 19 2103 2860
Fax: +55 19 2103 2862
latam.boschsecurity@bosch.com
www.boschsecurity.com