

# SENTECH

## USB3 Vision C-MOSIS Series Product Specifications



### Features

- USB3 Vision Compatibility
- 2 or 4 MP C-MOSIS Sensors
- 150 or 80 FPS
- Available with Near IR Sensor

## Safety / Product Precautions

### Safety Precautions

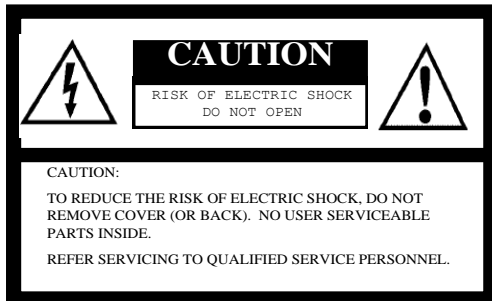

The lightning flash with arrowhead symbol, within an equilateral triangle, is intended to alert the user to the presence of uninsulated “dangerous voltage” within the product’s enclosure that may be of sufficient magnitude to constitute a risk of electric shock to persons.



The exclamation point within an equilateral triangle is intended to alert the user to the presence of important operating and maintenance (servicing) instructions in the literature accompanying the appliance.

For U.S.A.

Warning:

This equipment generates and uses radio frequency energy and if not installed and used properly, i.e., in strict accordance with the instruction manual, may cause harmful interference to radio communications. It has been tested and found to comply with the limits for a Class A computing device pursuant to Subpart J of Part 15 of FCC Rules, which are designed to provide reasonable protection against such interference when operated in a commercial environment.

For Canada

Warning:

This digital apparatus does not exceed the Class A limits for radio noise emissions from digital apparatus set out in the Radio Interference Regulations of the Canadian Department of Communications.

WARNING:

TO PREVENT FIRE OR SHOCK HAZARD, DO NOT EXPOSE THIS APPLIANCE TO RAIN OR MOISTURE.

### Product Precautions

- Handle the camera with care. Do not abuse the camera. Avoid striking or shaking it. Improper handling or storage could damage the camera.
- Do not pull or damage the camera cable.
- During camera use, do not wrap the unit in any material. This will cause the internal temperature of the unit to increase.
- Do not expose the camera to moisture, or do not try to operate it in wet areas.
- Do not operate the camera beyond its temperature, humidity and power source ratings.
- While the camera is not being used, keep the lens or lens cap on the camera to prevent dust or contamination from getting in the sensor or filter area and scratching or damaging this area.
- Do not keep the camera under the following conditions:
  - In wet, moist, and high humidity areas
  - Under hot direct sunlight
  - In high temperature areas
  - Near an object that releases a strong magnetic or electric field
  - Areas with strong vibrations
- Apply the power that satisfies the requirements specified in this document to the camera.
- Use a soft cloth to clean the camera. Use pressured air spray to clean the surface of the glass. DO not scratch the surface of the glass.

- The camera is a general-purpose electronic device; using the camera for the equipment that may threaten human life or cause dangers to human bodies directly in case of failure or malfunction of the camera is not guaranteed. Use the camera for special purposes at your own risk.
- Defect pixels may appear due to the sensor characteristics.
- During camera use, do not plug or unplug other USB devices (USB storage, etc.). Plugging or unplugging other devices may result in a failure to recognize the USB camera.
- Increasing gain level also increases the noise level.
- The noise level will increase when in long exposure mode.

## Contents

<b>1</b>	<b>OVERVIEW</b> .....	<b>5</b>
1.1	FEATURES.....	5
1.2	ITEM NUMBERS NAMING METHOD.....	5
<b>2</b>	<b>SPECIFICATIONS</b> .....	<b>6</b>
2.1	ELECTRONIC SPECIFICATIONS (STC-MCCM200U3V/STC-MBCM200U3V).....	6
2.2	ELECTRONIC SPECIFICATIONS (STC-MCCM401U3V/STC-MBCM401U3V).....	7
2.3	SPECTRAL SENSITIVITY CHARACTERISTICS.....	9
2.3.1	STC-MBCM200U3V / STC-MBCM401U3V.....	9
2.3.2	STC-MCCM200U3V / STC-MCCM401U3V.....	9
2.3.3	STC-MBCM200U3V-NIR / STC-MBCM401U3V-NIR (Near IR model).....	10
2.4	FILTER SPECIFICATION(STC-MCCM200U3V / STC-MCCM401U3V).....	10
2.5	MECHANICAL SPECIFICATIONS.....	11
2.6	ENVIRONMENTAL SPECIFICATIONS.....	11
2.7	POWER / IO CONNECTOR.....	12
2.7.1	Pin assignment.....	12
2.7.2	Input Output DC characteristics.....	12
2.7.3	Default Setting of Input Output.....	13
2.7.4	GPIO Circuit (Input).....	13
2.7.5	GPIO Circuit (Output).....	14
2.8	DETAIL OF CAMERA FUNCTION.....	17
2.8.1	ROI.....	17
<b>3</b>	<b>DIMENSIONS</b> .....	<b>19</b>
<b>4</b>	<b>REVISION HISTORY</b> .....	<b>20</b>

## 1 Overview

This document describes the specification of the following cameras.

STC-MBCM200U3V / MCCM200U3V / MBCM200U3V-NIR (2M)  
STC-MBCM401U3V / MCCM401U3V / MBCM401U3V-NIR (4M)

### 1.1 Features

- USB3 Vision
- 167fps@2M, 89fps@4M
- CMOS Global
- Up to 64 Pixel Defect Correction (Default: ON) \*1
- 8bit,10bit, 12bit output

1: Even when the camera is initialized, the pixel blemish static collection data will not be initialized on the EEPROM. The pixel blemish static collection data on the EEPROM can be set after the camera has read-out the data.

### 1.2 Item Numbers Naming Method

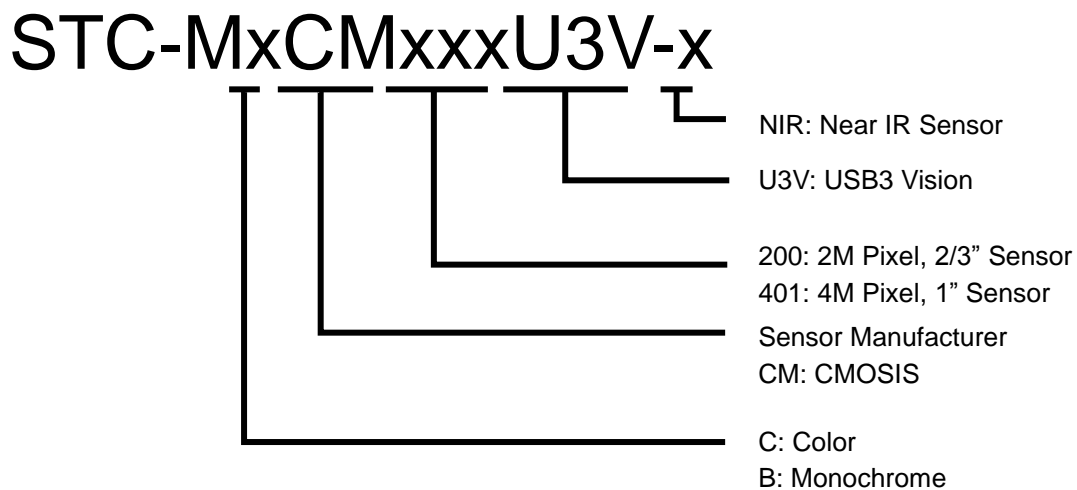

Figure 1: Naming Method

## 2 Specifications

### 2.1 Electronic Specifications (STC-MCCM200U3V/STC-MBCM200U3V)

Model Number		STC-MCCM200U3V	STC-MBCM200U3V
Image Sensor		2/3" 2M pixel Color CMOS (CMOSIS: CMV2000)	2/3" 2M pixel Monochrome CMOS (CMOSIS: CMV2000)
Active Picture Elements		2048(H) x 1080(V)	
Cell Size		5.5 (H) x 5.5 (V) μm	
Scanning System		Progressive	
Shutter Type		Global Shutter	
Scanning Mode		Full Scanning, Variable ROI (Horizontal and Vertical)	
Maximum Frame Rate (Full Scanning Mode)		2M: 2048 x 1080: 167fps (Raw 8bit) *Frame rate will drop if connected with the USB2.0 port	
Maximum Frame Rate (AOI Mode)		1280 x 1024: 177fps, 640 x 480: 370fps, Minimum AOI (32 x 32): 3500 fps	
Sync. System		Internal	
Video Output Format		RAW8bit /10bit / 12bit (Default Raw8bit)	
S/N Ratio (8bit)		Less than TBD digit (Gain 0 dB)	
Minimum Scene Illumination		TBD lx at F1.2	TBD lx at F1.2
Electronic Shutter		Preset · Free-run Mode: Exposure Time 22 usec to 16 sec (in full scanning mode) Preset · Trigger Mode: Exposure Time 22 usec to 16 sec (in full scanning mode)	
Gain	Analog	Not supported	
	Digital	0 ~ 13.9 dB (Default 0dB)	
Offset	Analog	0 to 255 digit (for 12bit/pix data) 8bit: 0 to 15digit	
ROI		ROI (Horizontal : 32 to 2048 pixels / Vertical : 32 to 1088 lines) (Default: 2048 x 1088) Adjustable Steps for offset: 2 pixels in horizontal direction and 2 lines in vertical direction Adjustable Steps for image size: 16 pixels in horizontal direction and 4 lines in vertical direction Adjustable Steps for ROI 8 Region, 16 pixels in horizontal direction and 4 lines in vertical direction	
Binning Function		N/A	Individual x2, x4 Horizontal, Vertical Binning (Frame rate does not increase)
Decimation Function		x2, x4 Vertical Decimation	Individual x2, x4 Horizontal, Vertical Decimation (Frame rate might be increased on Vertical, Frame rate might not be increased on Horizontal)
ALC		AE,AGC (Default AE:OFF, AGC:OFF)	
White Balance		Auto, Manual, One Push (Default: Manual)	N/A
HDR		N/A	Supported
Mirror Image		Horizontal / Vertical / Horizontal and Vertical (Default: OFF)	
Pixel Defect Correction		Up to 64 pixels (Default: ON)	
Operational Mode *4		Free-run / Edge-preset Trigger / Pulse width trigger	
User Setting Storage		Supported	
Interface		USB3.0 Super speed (USB3.0 Micro B)	
Input / Output		Three GPIO, One Camera Hardware Reset	
Power	Input Voltage	+5V(typ.) (Conform to USB Standard)	
	Consumption	Less than TBD W	

**Table 1: Electronic Specifications (STC-MCCM200U3V/STC-MBCM200U3V)**

## 2.2 Electronic Specifications (STC-MCCM401U3V/STC-MBCM401U3V)

Model Number		STC-MCCM401U3V	STC-MBCM401U3V
Image Sensor		1" 4M pixel Color CMOS (CMOSIS: CMV4000)	1" 4M pixel Monochrome CMOS (CMOSIS: CMV4000)
Active Picture Elements		2048(H) x 2048(V)	
Cell Size		5.5 (H) x 5.5 (V) μm	
Scanning System		Progressive	
Shutter Type		Global Shutter	
Scanning Mode		Full Scanning, Variable ROI (Horizontal and Vertical)	
Maximum Frame Rate (Full Scanning Mode)		4M: 2048 x 2048: 89fps (Raw 8bit), 45fps (Raw10bit), 37fps (Raw12bit) *Frame rate will drop if connected with the USB2.0 port	
Maximum Frame Rate (AOI Mode)		1280 x 1024: 177fps, 640 x 480: 370fps, Minimum AOI (32 x 32): 3500 fps	
Sync. System		Internal	
Video Output Format		RAW8bit / 10bit / 12bit (Default Raw8bit)	
S/N Ratio (8bit)		Less than 3 digit (Gain 0 dB)	
Minimum Scene Illumination		TBD lx at F1.2	TBD lx at F1.2
Electronic Shutter		Preset • Free-run Mode: Exposure Time 22 usec to 16 sec (in full scanning mode) Preset • Trigger Mode: Exposure Time 22 usec to 16 sec (in full scanning mode)	
Gain	Analog	Not supported	
	Digital	0 ~ 13.9 dB (Default 0dB)	
Offset	Analog	0 to 255 digit (for 12bit/pix data) 8bit: 0 to 15digit	
ROI		ROI (Horizontal : 32 to 2048 pixels / Vertical : 32 to 2048 lines) (Default: 2048 x 2048) Adjustable Steps for offset: 2 pixels in horizontal direction and 2 lines in vertical direction Adjustable Steps for image size: 16 pixels in horizontal direction and 4 lines in vertical direction Adjustable Steps for ROI 8 Region, 16 pixels in horizontal direction and 4 lines in vertical direction	
Binning Function		N/A	Individual x2, x4 Horizontal, Vertical Binning (Frame rate does not increase)
Decimation Function		x2, x4 Vertical Decimation	Individual x2, x4 Horizontal, Vertical Decimation (Frame rate might be increased on Vertical, Frame rate might not be increased on Horizontal)
ALC		AE,AGC (Default AE:OFF, AGC:OFF)	
White Balance		Auto, Manual, One Push (Default: Manual)	N/A
HDR		N/A	Supported
Mirror Image		Horizontal / Vertical / Horizontal and Vertical (Default: OFF)	
Pixel Defect Correction		Up to 64 pixels (Default: ON)	
Operational Mode		Free-run / Edge-preset Trigger / Pulse width trigger	
User Setting Storage		Supported	
Interface		USB3.0 Super speed (USB3.0 Micro B)	
Input / Output		Three GPIO, One Camera Hardware Reset	
Power	Input Voltage	+5V(typ.) (Conform to USB Standard)	
	Consumption	Less than TBD W	

**Table 2: Electronic Specifications (STC-MCCM401U3V/STC-MBCM401U3V)**

## Precautions

- \* The Binning & the Decimation units do not change.
- \* Several regions cannot be set on the same horizontal line.
- \* Binning & Decimation cannot work simultaneously.
- \* The user should not input the trigger more frequently than the maximum frame rate.

If the trigger was input during the sensor ReadOut timing, the ReadOut will be interrupted. This trigger will cause the exposure to end.

For further information in regards to the ROI, please refer to Section: [2.8.1 ROI](#).

## How to obtain full frame rate

This general guideline may help the user obtain the full frame rate (2M:167fps, 4M:89fps) from the camera.

To obtain the full frame rate (2M:167fps,4M:89fps), the data transfer speed on the USB bus depends on the capability of the host controller.

Renesas / Fresco Logic 's host controller improved the data transfer speed drastically in the second generation, Intel's chipset increased the transfer speed 10% to 20%. To obtain the image with maximum frame rate, the Intel may cause a lower frame.

When the PCIExpress board of USB3.0 interface is used, please insert the PCIExpress Gen2.0(5.0[GT/s]) slot. If non-PCIExpress Gen2.0(5.0[GT/s]) is used, data transfer speed could decrease up to 50%.

If an incompatible host controller causes the frame rate to drop, the frame rate should be set lower than maximum to adjust for the incompatible host controller spec.

Due to the huge data transfer, PC resources may be consumed during the process. If this occurs, frame rate may be affected.



## 2.3 Spectral Sensitivity Characteristics

### 2.3.1 STC-MBCM200U3V / STC-MBCM401U3V

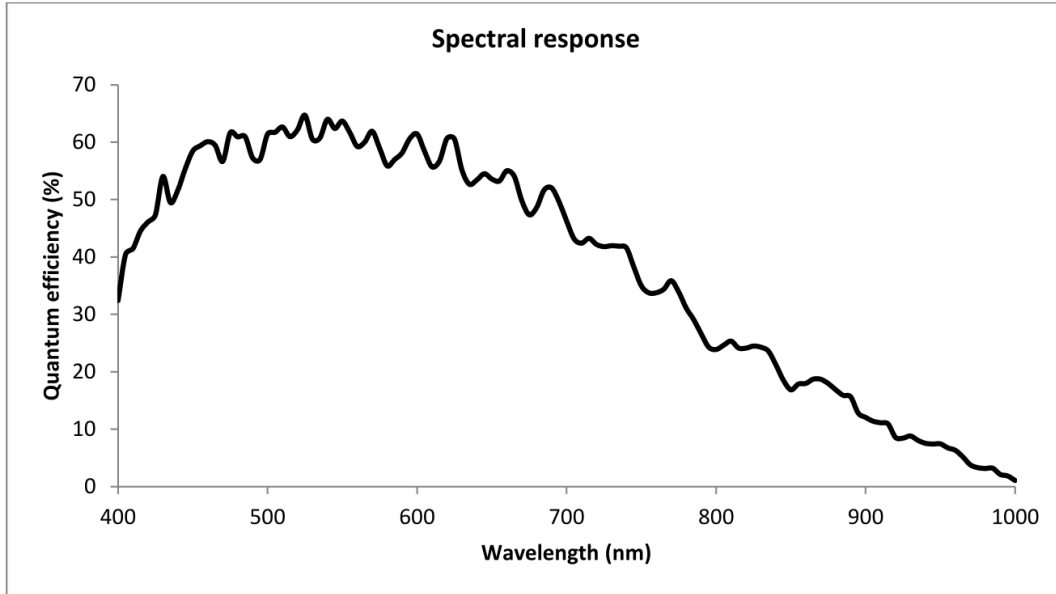

### 2.3.2 STC-MCCM200U3V / STC-MCCM401U3V

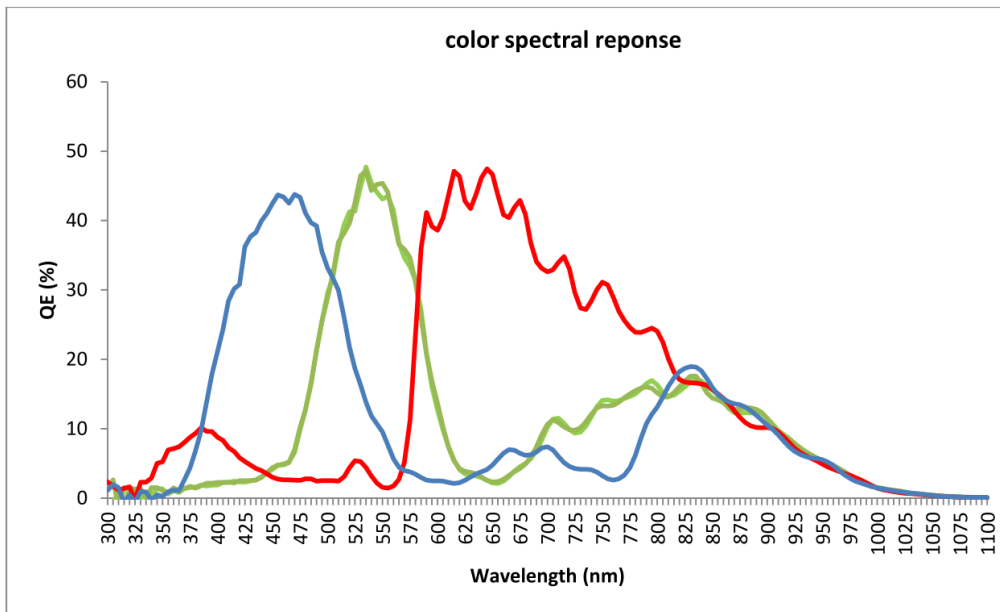

### 2.3.3 STC-MBCM200U3V-NIR / STC-MBCM401U3V-NIR (Near IR model)

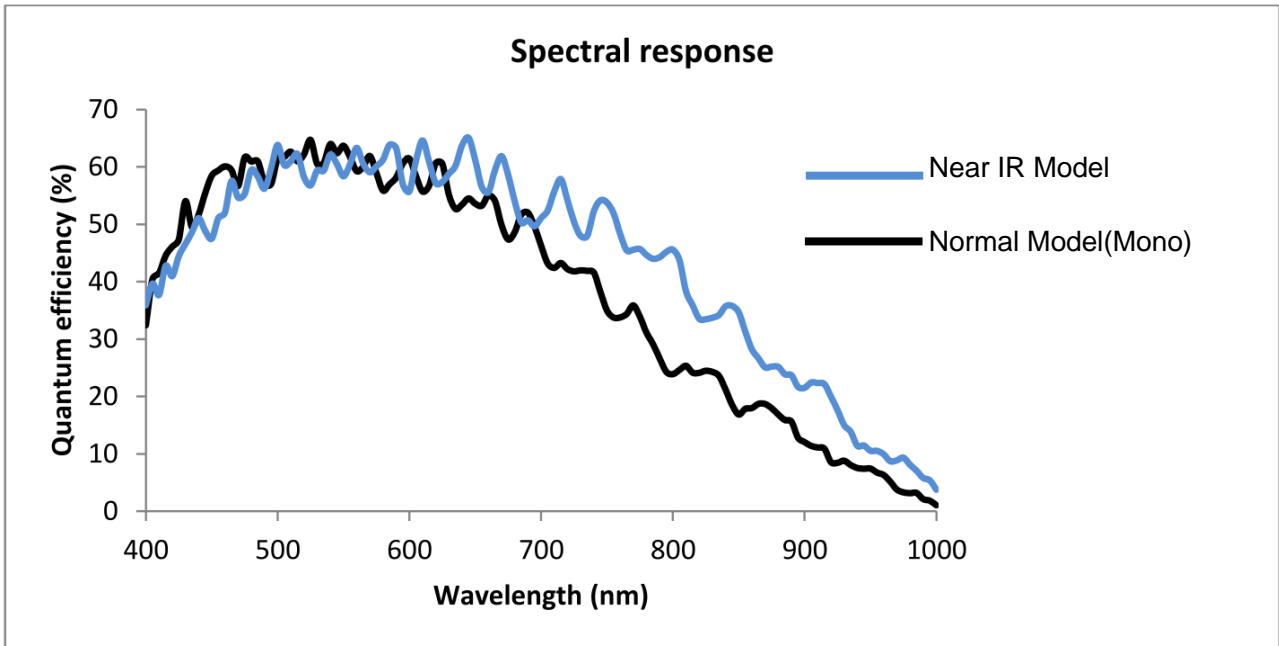

### 2.4 Filter Specification(STC-MCCM200U3V / STC-MCCM401U3V)

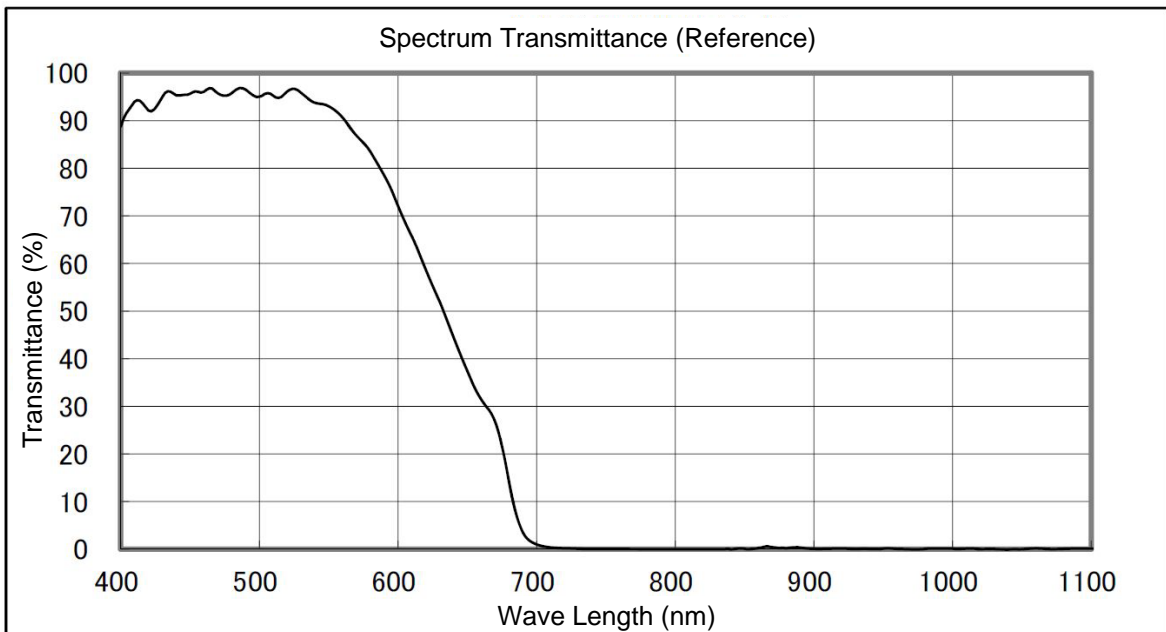

## 2.5 Mechanical Specifications

Model Number	STC-MCCM200U3V/MCCM401U3V	STC-MBCM200U3V/MBCM401U3V
Dimensions	C Mount: 28 (W) x 28 (H) x 40 (D) mm *excluding the connectors	
Lens Mount	C Mount	
Optical Filter	IR Cut Filter	No IR Cut Filter
Optical Center Accuracy	Positional accuracy in Horizontal and Vertical directions: +/- 0.31 mm Rotational accuracy of Horizontal and Vertical: +/- 1.5 deg.	
Weight	Approximately 52 g	
Interface Connectors	USB Connector: USB3.0 Micro B type I/O Connector: HR10A-7R-6PB (Hirose) or equivalent	

**Table 3: Mechanical Specifications**

## 2.6 Environmental Specifications

Model Number	STC-MCCM200U3V/MBCM200U3V STC-MCCM401U3V/MBCM401U3V	
Operational Temperature	Minimum	Environmental Temperature: -5 deg. C
	Maximum	Camera housing temperature (top plate) shall not exceed 55 deg. C *1
Storage Temperature	Environmental Temperature: -30 to +65 deg. C	
Vibration	20Hz to 200Hz to 20Hz (5min./cycle), acceleration 10G, XYZ 3 directions 30 min. each	
Shock	Acceleration 38G, half amplitude 6ms, XYZ 3 directions 3 times each	
Standard Compliancy	TBD (EMS: EN61000-6-2, EMI: EN55011)	
RoHS	RoHS Compliant	

**Table 4: Environmental Specifications**

\*1: Please insure the camera is installed with the appropriate heat dissipation. If the camera has mounted lens and tripod with an aluminum plate, this could decrease the camera housing temperature for heat dissipation. When the internal temperature sensor on the camera shows less than 63°C, the camera housing temperature (top plate) will be less than 55°C.

## 2.7 Power / IO Connector

HR10A-7R-6PB (Hirose) or equivalent.

This connector is for the 12Vdc power input and the input and output signals.

The trigger input and sync input /output signals can be assigned through the camera communication.

As for the cable part (Female connector), HR10A-7P-6S (Hirose) or equivalent can be used.

### 2.7.1 Pin assignment

Pin No.	Signal Name	IN/OUT
1	IO_GND	-
2	GPIO2	IN/OUT
3	GPIO1	IN/OUT
4	GPIO0	IN/OUT
5	CAM_RESET	IN
6	N.C.	-

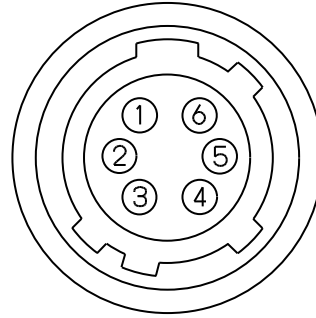

\*Possible Maximum Rated Voltage is +24V.on CAM\_RESET,GPIO0,GPIO1,GPIO2.

\*Please electrically "OPEN" on NC (Pin 6).

### 2.7.2 Input Output DC characteristics

Pin No.	Signal Name	Function	IN/OUT	Voltage		Current	Reference	
				Low Voltage	High Voltage			
1	IO_GND	GND	-			-	-	
2	GPIO2	General Purpose Input Output	IN/OUT	IN	Less than+1.00V	+3.00 to +24V	4uA(typ.)	2
				OUT	0 to +2.20V(*1)	+3.00 to +24V(*2)	15mA(Max.)(*3)	3,4
3	GPIO1	General Purpose Input Output	IN/OUT	IN	Less than+1.00V	+3.00 to +24V	4uA(typ.)	2
				OUT	0 to +2.20V(*1)	+3.00 to +24V(*2)	15mA(Max.)(*3)	3,4
4	GPIO0	General Purpose Input Output	IN/OUT	IN	Less than+1.00V	+3.00 to +24V	4uA(typ.)	2
				OUT	0 to +2.20V(*1)	+3.00 to +24V(*2)	15mA(Max.)(*3)	3,4
5	CAM_RESET	Camera Hardware Reset	IN	IN	Less than +0.80V	+3.00 to +24V	4uA(typ.)	1
6	N.C.	NC	-		-	-	-	

\*1: If the current on the IO port is at 15mA when using low voltage output, the output voltage could increase for the internal register.

\*2: When an output IO is used, the maximum value of the voltage that can be applied to connect the circuit is determined by the external IO.

(The measured circuit is equivalent to 4VCCext).

\*3: When used as an output IO while connecting a circuit that is configured by an outside source, the current flowing through the IO pin should be within 15mA.

### 2.7.3 Default Setting of Input Output

Pin No.	Signal Name	Default	
		IN/OUT	Setting
2	GPIO2	IN	Disable
3	GPIO1	IN	Disable
4	GPIO0	IN	Disable

### 2.7.4 GPIO Circuit (Input)

#### Input Signal Functions

No.	Function	Polarity
1)	Disable (Default)	-
2)	General Input	-
3)	Trigger Input	Positive or Negative

- 1) Disable  
This function is set when no input signal is necessary.
- 2) General Input  
This function can be set high or low level and the user can check the status on the software.
- 3) Trigger Input  
Use this function for the trigger signal in the edge preset mode.

#### CAM\_RESET(Reference 1)

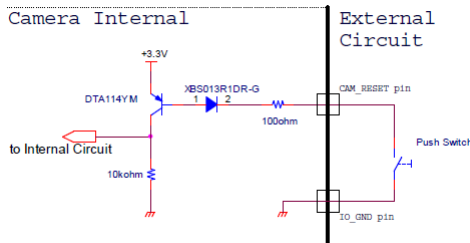

The camera can be reset after connecting the GND in 5 seconds on this circuit. Hardware Reset should be set from OFF(Default) to ON.

#### General Purpose Input (Reference 2)

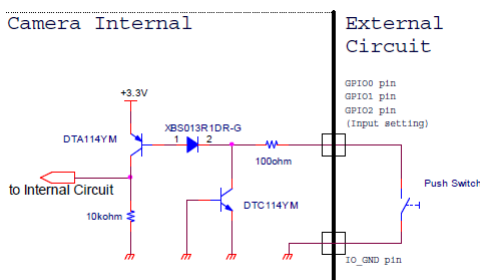

## Input Response Characteristics

Response characteristics of CAM\_RESET(Reference1) & General Purpose Input (Reference 2) are shown in the diagram below:

Td	0.06 usec
Tr	0.07 usec
Ts	4.06 usec
Tf	3.90 usec

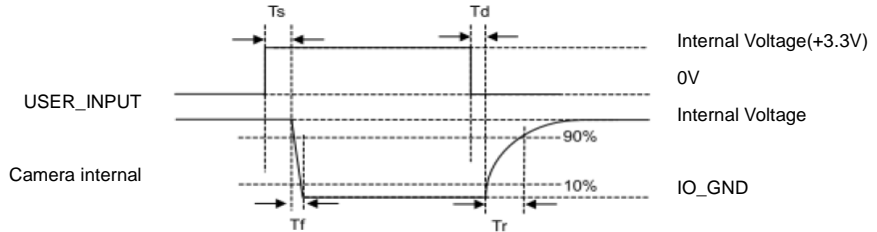

Capable input trigger's pulse width is  
 Positive Edge: more than  $T_s + T_f$   
 Negative Edge: more than  $T_d + T_r$

## 2.7.5 GPIO Circuit (Output)

### Output Signal Functions

No/	Function	Polarity
1)	Disable (Default)	-
2)	General Output	-
3)	Trigger Output (Programmable)	Positive or Negative
4)	Trigger Output (Loop Through)	Positive or Negative
5)	Exposure End	Positive or Negative
6)	CCD Read End Output	Positive or Negative
7)	Strobe Output (Programmable)	Positive or Negative
8)	Strobe Output (Exposure)	Positive or Negative
9)	Trigger Valid Out	Positive or Negative
10)	Transfer End	Positive or Negative

- 1) Disable  
This function is set when no output signal is necessary.
- 2) General Output  
This function outputs high or low level signal and can be set on the software.
- 3) Trigger Output (Programmable)  
This function outputs the trigger input signal with pulse delay setting and pulse duration applied.
- 4) Trigger Output (Loop Through)  
This function outputs the trigger input signal (with a slight internal delay).
- 5) Exposure End  
This function outputs with pulse delay setting and pulse duration applied when the exposure is completed.

- 6) CCD Read End Output  
This function outputs with pulse delay setting and pulse duration applied when one frame transfer from the sensor is completed.
- 7) Strobe Output (Programmable)  
This function outputs with strobe delay setting and strobe duration applied when the trigger input signal is received.
- 8) Strobe Output (Exposure)  
\*Actual exposure duration = Output Pulse Width + Minimum Exposure Time 22 usec
- 9) Trigger Valid Out  
When using the positive polarity setting, high status indicates that the input trigger signal is acceptable. This signal becomes low from the exposure start to the end of image output.  
When using the negative polarity setting, low status indicates that the input trigger signal is acceptable. This signal becomes high from the exposure start to the end of image output.
- 10) Transfer End  
This function outputs with pulse delay setting and pulse duration applied when one frame transfer from the camera is completed.

### General Purpose Output (Reference 3)

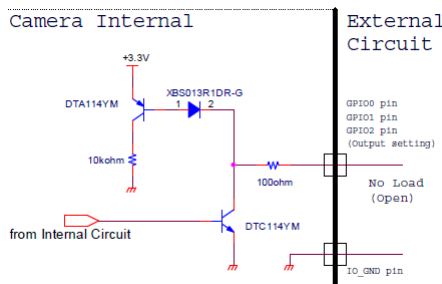

### General Purpose Output (Reference 4)

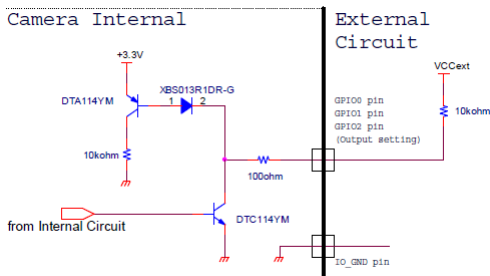

## Characteristics of the output signals

The response characteristics of General Purpose output (Reference 3) and General Purpose output (Reference 4) are shown in the diagrams below. The pulse width is configurable through the control software.

Please refer to the following response timing table, and use appropriate timing for the setting of the output pulse width does not include these characteristics.

	VCCext			
	OPEN(*1)	5V (*2)	12V (*2)	24V (*2)
Td	2.76 usec	2.73 usec	2.70 usec	2.63 usec
Tr	12.27 usec	1.56 usec	1.48 usec	1.43 usec
Ts	0.06 usec	0.07 usec	0.08 usec	0.09 usec
Tf	0.05 usec	0.07 usec	0.11 usec	0.16 usec

\*1: Reference 3. Measured on +3.3V internal Voltage.

\*2: Reference 4

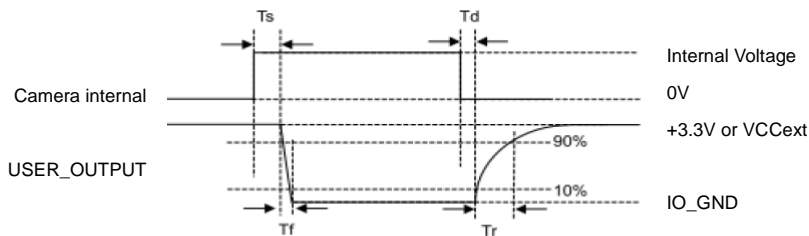



## 2.8 Detail of Camera Function

### 2.8.1 ROI

When using the ROI function, please follow the precautions shown below:

The image data format on MultiROI is Sentech's original format, this data does not follow USB3Vision format. Therefore, the MultiROI function does not work on 3rd party's USB3Vision compliance application.

If user use MultiROI function, as follows application should be required.

- Applications based on Sentech's SDK(Standard/Trigger)
- Applications based on Sentech's DirectShowFilter
- Applications based on Sentech's GenTL module(※)
- ※ Implementing the process for Sentech's original format in the user's application is necessary.

MultiROI can be set 8 regions as Region0~7.

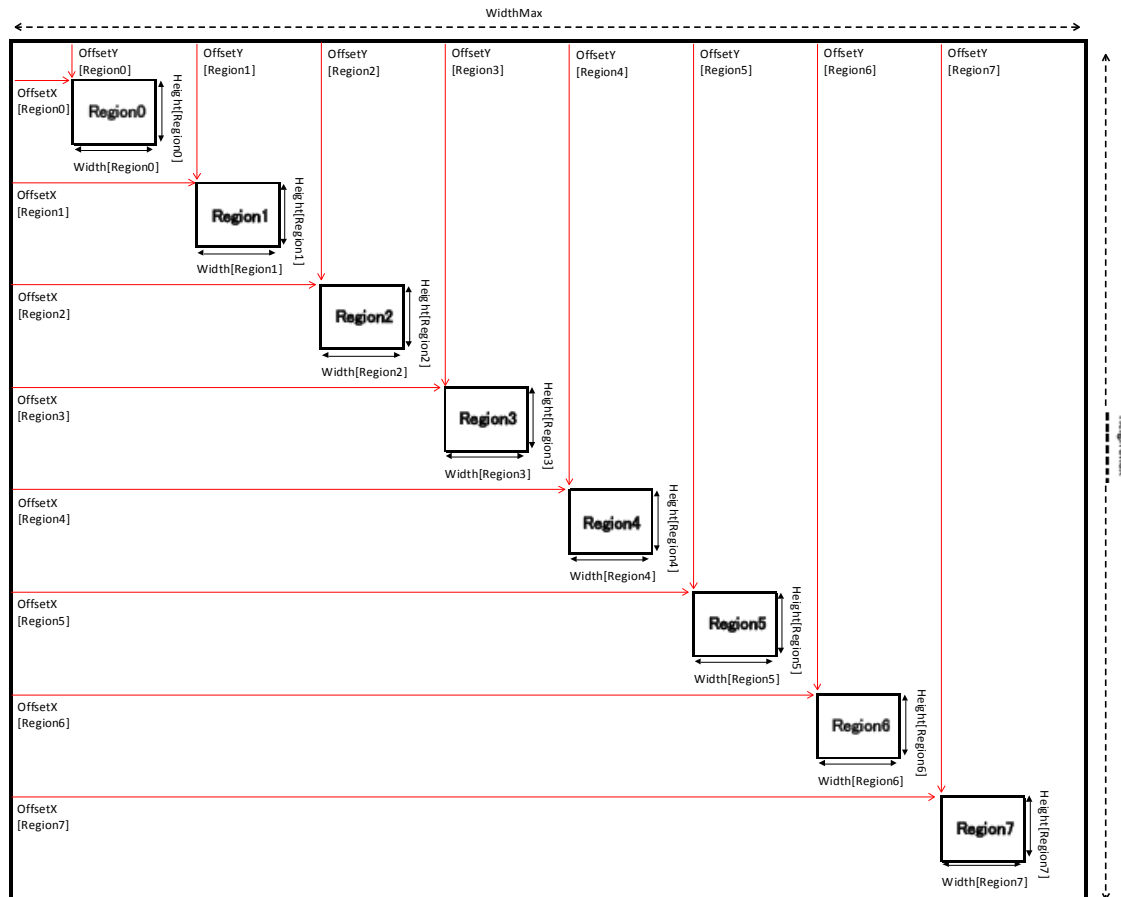

Region number from 0 to 7 should be set from top of image. Several regions cannot be set on the same horizontal line.

ON/OFF can be assigned for each region.

It is prohibited for the user to replace a region.

Please set the smaller setting on the smaller region and the larger setting on the larger region.

It is prohibited to overlap the images.

Region number 0 to 7 should be assigned a rotated image when Horizontal / Vertical / Horizontal and Vertical setting is used on the camera.

The camera will output all of active region's as one image data.

Width and Height corresponds to the obtained image's size.

When the Binning/Decimation is enabled, Binning/Decimation size should correspond.

## 3 Dimensions

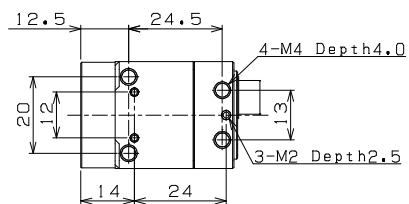
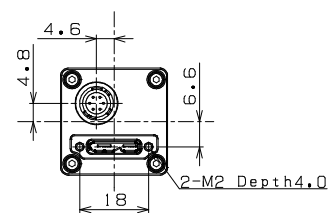
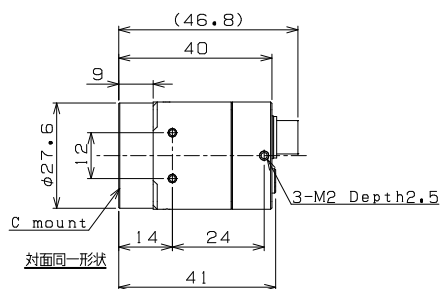
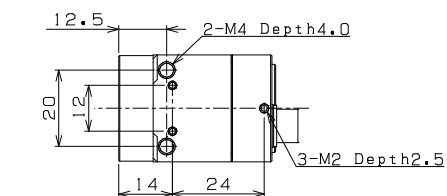
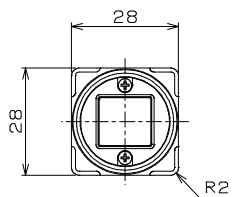
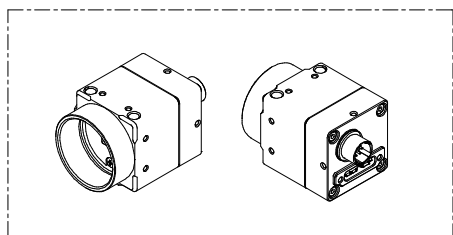

Unit: mm

## 4 Revision History

Rev	Date	Changes	Note
00	2014/08/01	●	
1.01	2014/08/11	● Updated to Full English Translation	RM

**Sensor Technologies America, Inc.**

1345 Valwood Pkwy, Suite 320

Carrollton, TX 75006

TEL: (972)-481-9223

FAX: (972)-481-9209

[www.SentechAmerica.com](http://www.SentechAmerica.com)

**Sentech Co., Ltd**

7F, Harada center building

9-17, Naka cho 4 chome

Atsugi-city, Kanagawa

243-0018 Japan

TEL +81-46-295-7061 FAX +81-46-295-7066

URL <http://www.sentech.co.jp/>