

DS-2TD2136-25/V1 Thermal Network Bullet Camera

DeepinView^{series}



Hikvision DS-2TD2136-25/V1 Thermal Network Bullet Camera equipped with built-in GPU which support intelligent behavior analysis algorithm, can realize high precision VCA detection and real-time alarm. It is applied to perimeter defense and fire-prevention purposes in critical infrastructures such as: airport, railway, prison, power station, 4S stores, and so on. The pre-alarm system helps you discover unexpected events immediately and protects you from property loss.

Smart Function (Thermal Imaging)

- Leading image processing technology: Adaptive AGC, DDE, 3D DNR, NETD less than 40mk (@25°C, F#=1.0)
- Powerful behavior analysis function, based on deep learning algorithm: Line crossing, Intrusion, Region Entrance & Exit
- Reliable temperature exception alarm function
- Advanced fire detection algorithm

Thermal Imaging Module Function

- 384 × 288 resolution sensor, high sensitivity sensor, support contrast adjustment
- Shutter adjustment in various modes
- 3D DNR, 15 palettes of color adjustable, image detail enhancement



Specifications

Thermal Module	
Image Sensor	Vanadium Oxide Uncooled Focal Plane Arrays
Max. Resolution	384 × 288
Pixel Interval	17 μm
Response Waveband	8 μm to 14 μm
NETD	less than 40mk (@25°C,F#=1.0)
Lens (Focal Length)	25 mm
MRAD	0.68 mrad
Field of View	14.88° × 11.19° (H × V)
Min. Focusing Distance	13 m
Aperture	F 1.0
Smart Function	
VCA (Video Content Analysis)	4 VCA rule types (Line Crossing, Intrusion, Region Entrance, and Region Exiting), up to 8 VCA rules.
Temperature Measurement	3 temperature measurement rule types, 21 rules (10 points, 10 regions, and 1 line).
Temperature Range	-20 °C to 150 °C (-4 °F to 302 °F)
Temperature Accuracy	±8 °C (14.4 °F)
Fire detection	Dynamic fire point detection, up to 10 fire points detectable.
Network	
Main Stream	50fps (384×288)
Sub Stream	50fps (384×288)
Third Stream	50fps (384×288)
Video Compression	H.265/H.264/MJPEG, H.265+/H.264+ encoding with Baseline/Main/High Profile
Audio Compression	G.711u/G.711a/G.722.1/MP2L2/G.726/PCM
Protocols	IPv4/IPv6, HTTP, HTTPS, 802.1x, Qos, FTP, SMTP, UPnP, SNMP, DNS, DDNS,NTP, RTSP, RTCP, RTP, TCP, UDP, IGMP, ICMP, DHCP, PPPoE
Simultaneous Live View	Up to 20
User/Host level	Up to 32 users, 3 levels: Administrator, Operator, User
Security Measures	User authentication (ID and PW), MAC address binding, HTTPS encryption, IEEE 802.1x access control, IP address filtering
Integration	
Alarm Input	2-ch inputs (0-5V DC)
Alarm Output	2-ch relay outputs, alarm response actions configurable
Alarm Action	Preset/Patrol Scan/Pattern Scan/SD Card Record/Relay Output/Smart capture/FTP upload/Email linkage
Audio Input	1 3.5mm Mic in/Line in interface. Line input: 2-2.4V[p-p], output impedance:1KΩ±10%

Integration	
Audio Output	Linear Level; Impedance: 600Ω
Ethernet	1 RJ45 10M/100M Self-adaptive Ethernet interface
SD Memory Card	Built-in Micro SD card slot, support Micro SD/SDHC/SDXC card (up to 128G), support manual/alarm recording
Analog Video Output	1.0V [p-p]/75Ω, PAL/NTSC/BNC
Application Programming	Open-ended API, support ISAPI, HIKVISION SDK and third-party management platform
Client	iVMS-4200
Web Browser	IE9+, chrome31-chrome44, Firefox 30-Firefox51, Safari 5.02+(mac)
General	
Menu language	English
Power	24 VAC± 25%, 12 VDC± 20%, two-core terminal block PoE (802.3at, class 4)
Power Consumption	24 VAC± 25%: 0.84 A, 12 VDC ± 20%: 1.7 A, max. 8W (20W with De-icing Heater On), PoE (802.3at, class 4): 42.5 V to 57 V, 0.4 A to 0.5 A
Working Temperature/Humidity	-40 °C to 65 °C (-40 °F to 149 °F), 90% or less
Protection Level	IP66 Standard TVS 6000V Lightning protection, surge protection, voltage transient protection
Dimensions	314mm × 104mm × 292.7mm (12.36" × 4.09" × 11.52")
Weight	Approx. 2kg (4.41lb)

Detection Range Table

* The table is only for reference, the performance may vary from camera to camera.

Smart functions Range

Different targets trigger the VCA events within different range limits.

VCA Range (Vehicles: 1.4×4.0m)	VCA Range (Humans: 1.8×0.5m)	Temperature Measurement (Object:2×2 m)	Temperature measurement (Object:1×1 m)	Fire Detection (Object:2×2 m)	Fire Detection (Object:1×1 m)
750 m	250 m	585 m	295 m	1470 m	735 m

Wide Range Coverage

There is range limit for detecting, recognizing, and identifying human/vehicle targets.

Detection Range (Vehicles: 1.4×4.0m)	Detection Range (Humans: 1.8×0.5m)	Recognition Range (Vehicles: 1.4×4.0m)	Recognition Range (Humans: 1.8×0.5m)	Identification Range (Vehicles: 1.4×4.0m)	Identification Range (Humans: 1.8×0.5m)
2255 m	735 m	564 m	184 m	282 m	92 m

Available Model

DS-2TD2136-25/V1

Dimensions

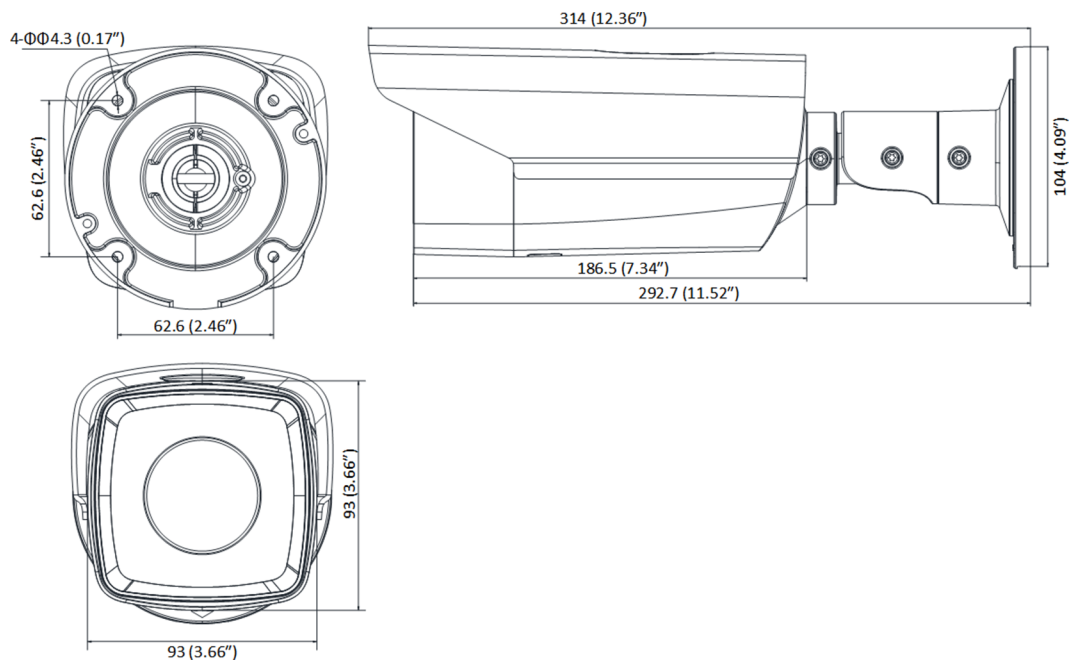

Distributed by

**HIKVISION®****Headquarters**

No.555 Qianmo Road, Binjiang District,
Hangzhou 310051, China
T +86-571-8807-5998
overseasbusiness@hikvision.com

Hikvision USA
T +1-909-895-0400
sales.usa@hikvision.com

Hikvision Australia
T +61-2-8599-4233
salesau@hikvision.com

Hikvision India
T +91-22-28469900
sales@pramahikvision.com

Hikvision Canada
T +1-866-200-6690
sales.canada@hikvision.com

Hikvision Thailand
T +662-275-9949
sales.thailand@hikvision.com

Hikvision Europe
T +31-23-5542770
sales.eu@hikvision.com

Hikvision Italy
T +39-0438-6902
info.it@hikvision.com

Hikvision Brazil
T +55 11 3318-0050
Latam.support@hikvision.com

Hikvision Turkey
T +90 (216)521 7070- 7074
sales.tr@hikvision.com

Hikvision Malaysia
T +601-7652-2413
sales.my@hikvision.com

Hikvision UK & Ireland
T +01628-902140
sales.uk@hikvision.com

Hikvision South Africa
Tel: +27 (10) 0351172
sale.africa@hikvision.com

Hikvision France
T +33(0)1-85-330-450
info.fr@hikvision.com

Hikvision Kazakhstan
T +7-727-9730667
nikia.panfilov@hikvision.ru

Hikvision Vietnam
T +84-974270888
sales.vt@hikvision.com

Hikvision UAE
T +971-4-4432090
salesme@hikvision.com

Hikvision Singapore
T +65-6684-4718
sg@hikvision.com

Hikvision Spain
T +34-91-737-16-55
info.es@hikvision.com

Hikvision Tashkent
T +99-87-1238-9438
uzb@hikvision.ru

Hikvision Hong Kong
T +852-2151-1761
info.hk@hikvision.com

Hikvision Russia
T +7-495-669-67-99
saleru@hikvision.com

Hikvision Korea
T +82-(0)31-731-8817
sales.korea@hikvision.com

Hikvision Poland
T +48-22-460-01-50
info.pl@hikvision.com

Hikvision Indonesia
T +62-21-2933759
Sales.Indonesia@hikvision.com

Hikvision Colombia
sales.colombia@hikvision.com