16:9 Format 1080p

STC-HD213 Series Color CMOS Camera

STC-HD213DV (DVI output / C mount)

STC-HD213DV-CS (DVI output / CS mount)

STC-HD213SDI (SDI output / C mount)

STC-HD213SDI-CS (SDI output / CS mount)

STC-HD213DVN (Non-Memory / DVI output / C mount)

STC-HD213DVN-CS (Non-Memory / DVI output / CS mount)

STC-HD213SDIN (Non-Memory / SDI output / C mount)

STC-HD213SDIN-CS (Non-Memory / SDI output / CS mount)

Product Specifications and User's Guide

OMRON SENTECH CO., LTD.

Table of Contents

1	Product Precautions	6
2	Warranty.....	6
3	Introduction	7
3.1	Features	7
3.2	Product Number Naming Method	7
3.3	Peripheral Equipment	8
4	Specifications.....	9
4.1	Electronic specifications	9
4.1.1	STC-HD213DV / STC-HD213DV-CS / STC-HD213DVN / STC-HD213DVN-CS	9
4.1.2	STC-HD213SDI / STC-HD213SDI-CS / STC-HD213SDIN / STC-HD213SDIN-CS	10
4.2	Spectral Sensitivity Characteristics	11
4.3	Mechanical Specifications.....	12
4.3.1	STC-HD213DV / STC-HD213DV-CS / STC-HD213DVN / STC-HD213DVN-CS	12
4.3.2	STC-HD213SDI / STC-HD213SDI-CS / STC-HD213SDIN / STC-HD213SDIN-CS	12
4.4	Environmental Specifications	13
4.4.1	STC-HD213DV / STC-HD213DV-CS / STC-HD213SDI / STC-HD213SDI-CS	13
4.4.2	STC-HD213DVN / STC-HD213DVN-CS / STC-HD213SDIN / STC-HD213SDIN-CS	13
4.5	External Control Specification	14
5	Dimensions.....	15
5.1	STC-HD213DV / STC-HD213DVN.....	15
5.2	STC-HD213DV-CS / STC-HD213DVN-CS.....	16
5.3	STC-HD213SDI / STC-HD213SDIN.....	17
5.4	STC-HD213SDI-CS / STC-HD213SDIN-CS.....	18
6	Camera instruction guide	19
6.1	Push Button	19

6.2	Camera Setting through External Switch (Remote Controller)	20
6.2.1	Camera Setting through Switch that has 3.5φStereo Pin Jack.....	20
6.2.2	Menu on screen with External Switch	21
7	Control Software User's Guide.....	34
7.1	System Requirements.....	34
7.2	Basic Operating Procedure	34
7.3	Button Description	35
7.4	The Differences of uCOM register and DSP register.....	35
7.5	Functional Description.....	36
8	The Communication Protocol Specifications.....	66
8.1	The communication settings.....	66
8.2	The communication format	66
8.3	Camera control commands	67
8.3.1	The command list for communication.....	67
8.3.2	Slave address for ICs (8bits) list.....	69
8.3.3	Error code list	69
8.4	The uCOM register mapping list	70
8.4.1	Push Button Function on Meru	77
8.4.2	Push button function list.....	78
8.5	The DSP register mapping list	80
8.6	OSCD (On Screen Character Display) Command.....	91
8.6.1	2 Byte Command.....	91
8.6.2	2 Byte consecutive Command	92
9	Revisions History.....	93

Precautions for safe use

Please read carefully this "Precautions for safe use" before use the camera. Then the camera uses correctly with agreeing with below notes.

In this "Precautions for safe use", notes divides into "Warning" and "Caution" to use the camera safety and prevent to harm and damage.

Warning	This shows, assumption for possibility of serious accident leading death or serious injury if ignore this note and camera uses incorrectly.
Caution	This shows, assumption for possibility of bear the damage or physical damage if ignore this note and camera uses incorrectly.

About Graphic symbols



This symbol shows general prohibition.







This symbol shows completion or instruction.

[Environment / condition]









Warning	
Do not use flammable or explosiveness atmospheres. This will cause of personal injury or fire.	Do not use for "safety for human body" related usage. This camera is designed for use "do not harm human body immediately" if by any chance the camera has malfunction.
Caution	
Use and store under specified environmental conditions (Vibration, shock, temperature, humidity) in the specifications for this camera. This will cause of fire or damage the camera.	

[Installation and cable wiring]



Warning	
Do not use with out of power voltage range that is specified in the specifications for this camera. This will cause of fire, electrification or malfunction.	Do not wrong wiring. This will cause of fire or malfunction.

 Caution	
 The camera housing is not connecting to 0 V line of camera inside circuit. There is a risk of short circuit between camera inside circuit and frame ground through other devices. This will cause of malfunction.	 It is necessary to wiring and mounting that is specified in the specifications for this camera. This will cause of fire or malfunction.
 It is necessary to wiring with turn off the camera. This will cause of electrification or malfunction.	 It is necessary to mounting the camera without stress for the cable. This will case of electrification or fire.



[Usage instruction]

 Warning	
 Do not touch the terminal and PCB board While turn on the camera. This will cause of electrification or accident caused by malfunction.	 Do not put combustibles near the camera. This will cause of fire.
 Do not use without usage that is specified in the specifications for this camera. This will cause of personal injury or malfunction.	 Do not push metals including screw driver into radiation holes. This will cause of electrification or malfunction.
 Caution	
 Do not push contamination into opening of the camera. This will cause of electrification or malfunction.	 Do not block the radiation holes. This will cause of fire due to increase the camera inside temperature.

[Maintenance]

 Caution	
 Do not disassemble or repair the camera. This will cause of fire, electrification or malfunction.	 It is turn off the camera when maintaining or inspecting the camera. This will cause of electrification.

[Disposal]

 Caution	
 It is necessary to dispose of accordance with WEEE directive. 	

1 Product Precautions

- Do not give shock to the camera.
 - Do not haul or damage the camera cable.
 - Do not wrap the camera with any material while using the camera. This will cause the internal camera temperature to increase.
 - When the camera moving or using the place that temperature difference is extreme, countermeasure for dew condensation (heat removal / cold removal) is necessary.
 - While the camera is not using, keep the lens cap on the camera to prevent dust or contamination from getting in the sensor or filter and scratching or damaging it.
- Do not keep the camera under the following conditions.
- In wet, moist, high humidity or dusty place
 - Under direct sunlight
 - In extreme high or low temperature place
 - Near an object that releases a strong magnetic or electric field
 - Place with strong vibrations
- Apply the power that satisfies the specified in specifications for the camera.
 - The defective pixels may appear due to the sensor characteristics.
 - Use below recommend materials (or equivalent materials) to clean the surface of glass.
 - Air dust: Non Freon air duster (NAKABAYASHI Co., LTD.)
 - Alcohol: Propan-2-ol (SAN'EI KAKO Co., LTD.)
 - Non-woven: nikowipe clean room (NKB)
 - Use a soft cloth to clean the camera.

2 Warranty

■Warranty period

One year after delivery (However, the camera had malfunction with camera uses correctly)

In below case for a fee even within warranty period.

- The malfunction caused by incorrect usage, incorrect modify or repair.
- The malfunction caused by external shock including the camera dropping after delivery the camera.
- The malfunction caused by fire, earthquake, flood disaster, thunderbolt struck, other natural disaster or wrong voltage.

■Warranty coverage

Exchange or repair the malfunction camera if the malfunction is occurred by our responsibility.

“Warranty” mean is warranty for the delivered camera itself. Please accept the induction damage by the camera malfunction is not included.

3 Introduction

This document describes specification of following cameras:

STC-HD213DV / STC-HD213DV-CS	(DVI output model)
STC-HD213SDI / STC-HD213SDI-CS	(SDI output model)
STC-HD213DVN / STC-HD213DVN-CS	(Non-Memory DVI output model)
STC-HD213SDIN / STC-HD213SDIN-CS	(Non-Memory SDI output model)

3.1 Features

- **1080p / 1080i / 720p output**
- **DVI / SDI Output**
- **Rolling shutter CMOS image sensor**
- **Camera adjustment with OSD (On Screen Character Display) through Remoter Controller (Option)**
- **Configurable many parameters through Control Software**
- **Eight configurable DSP User Presets can be saved**
- **Defective Pixel Correction (JTBCtrl software is required)**
- **Standard models (STC-HD213DV, HD213DV-CS, HD213SDI and HD213SDI-CS) and non-memory models that do not support “Still image”, “Digital zoom” and “Extended exposing” (STC-HD213DVN, HD213DVN-CS, HD213SDIN and HD213SDIN-CS) are available.**

3.2 Product Number Naming Method

STC-HD213xx-x

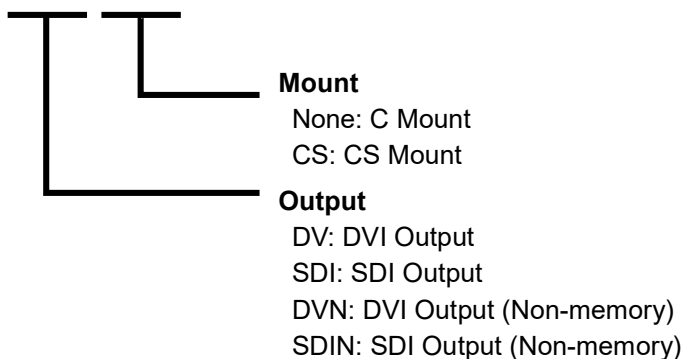

3.3 Peripheral Equipment

We supplying follow peripheral equipment as option.

+12V DC Power Supply: UN310-1210

Remote Controller: RC-HD133

Communication Tool (communicate through USB port on PC): JIG-USB-HD

Control Software: JTBCtrl (Free)



Note: This camera may become hot when operating 1080p60, 59.94, 50, 1080i60, 59.94, 50 output.
Please do not use camera without original camera housing.

4 Specifications

4.1 Electronic specifications

4.1.1 STC-HD213DV / STC-HD213DV-CS / STC-HD213DVN / STC-HD213DVN-CS

Model Number	STC-HD213DV / STC-HD213DV-CS	STC-HD213DVN / STC-HD213DVN-CS
Image Sensor	1/2.8" 2M Progressive Color CMOS (SONY: IMX291)	
Shutter Type	Rolling Shutter	
HD Active Picture Elements	1,920 (H) x 1,080 (V)	
Cell Size	2.9 (H) x 2.9 (V) μm	
Sync. System	Internal	
Video Output	DVI 1.0 conformity RGB 1080p60 / 1080p59.94 / 1080p50 / 1080p30 / 1080p25 / 1080i60 / 1080i59.94 / 1080i50 / 720p60 / 720p59.94 / 720p50 / Auto	
Minimum Scene Illumination	0.4 Lux (Maximum Gain) @ F1.4	
Camera Functions		
ALC	AEE (auto exposing) and AGC are configurable via UART communication (Default: ALC On)	
Shutter Speed	AEE or fixed exposure time control is selectable via UART communication (Default: AEE)	
Extended	Extend shutter frame unit (Up to 2.12 seconds)	N/A
High Speed	From 1/33,750 seconds (*1)	
Gain	AGC or Fixed gain is selectable via UART communication (Default: AGC) 0 to 45 dB	
Gamma	Gamma is selectable from manual and 8 preset (0.3 / 0.45 / 0.5 / 0.6 / 0.7 / 0.8 / 0.9 / 1) via UART communication (Default: Manual)	
White Balance	Auto white balance / Manual white balance / Push to set white balance White balance is selectable via UART (Default: Auto white balance)	
WDR	N/A	
Mirror Image	Horizontal flip / Vertical flip / Horizontal and vertical flip (180-degree rotation) / Normal image (Default: Normal image)	
DSP user Preset	8 User preset is selectable via UART communication (Default: Preset 0)	
Line Generator	Four lines (Two horizontal and two vertical lines with all available colors) (Default: Disable)	
Circle Line Generator	One circle (Default: Disable)	
Shadow Mask Generator	Both horizontal and vertical with shading level are adjustable via UART communication (Default: Disable)	
Still Image	Live video or freeze image is selectable via UART communication (Default: Live video)	N/A
Digital Zoom	Support	N/A
Communication	+3.3V UART communication via 3.5 Φ Stereo Jack (Baud rate: 115,200ps / 57,600bps / 38,400bps / 19,200bps / 9,600bps)	
Character Generator	Built-in character generation function via UART communication	
Defective Pixel Collection	Support (Up to 256 points)	
Power	Input Voltage	+9 to +15 Vdc (Typical: +12 Vdc)
	Consumption	Less than 3.2 W
		Less than 2.1 W

Default: **Bold**

(*1) The longest exposure time is depending on video output mode.

4.1.2 STC-HD213SDI / STC-HD213SDI-CS / STC-HD213SDIN / STC-HD213SDIN-CS

Model Number	STC-HD213SDI / STC-HD213SDI-CS	STC-HD213SDIN / STC-HD213SDIN-CS
Image Sensor	1/2.8" 2M Progressive Color CMOS (SONY: IMX291)	
Shutter Type	Rolling Shutter	
HD Active Picture Elements	1,920 (H) x 1,080 (V)	
Cell Size	2.9 (H) x 2.9 (V) μ m	
Sync. System	Internal	
Video Output	3G-SDI (Physical layer: SMPTE 424M, Data Mapping: SMPTE 425M Level-A Compliant), 4:2:2 YCbCr 10bit 1080p60 / 1080p59.94 / 1080p50 HD-SDI (SMPTE292M Compliant) 4:2:2 YCbCr 10bit 1080p30 / 1080p29.97 / 1080p25 / 1080i60 / 1080i59.94 / 1080i50 / 720p60 / 720p59.94 / 720p50 (Default: 1080i59.94)	
Minimum Scene Illumination	0.4 Lux (Maximum Gain) @ F1.4	
Camera functions		
ALC	AEE (auto exposing) and AGC are configurable via UART communication (Default: ALC On)	
Shutter Speed	AEE or fixed exposure time control is selectable via UART communication (Default: AEE)	
Extended	Extend shutter frame unit (Up to 2.55 seconds)	N/A
High Speed	From 1/33,750 seconds (*1)	
Gain	AGC or Fixed gain is selectable via UART communication (Default: AGC) 0 to 45 dB	
Gamma	Gamma is selectable from manual and 8 preset (0.3 / 0.45 / 0.5 / 0.6 / 0.7 / 0.8 / 0.9 / 1) via UART communication (Default: Manual)	
White Balance	Auto white balance / Manual white balance / Push to set white balance White balance is selectable via UART (Default: Auto white balance)	
WDR	N/A	
Mirror Image	Horizontal flip / Vertical flip / Horizontal and vertical flip (180-degree rotation) / Normal image (Default: Normal image)	
Picture Modes	8 User preset is selectable via UART communication (Default: Preset 0)	
Line Generator	Four lines (Two horizontal and two vertical lines with all available colors) (Default: Disable)	
Circle Line Generator	One circle (Default: Disable)	
Shadow Mask Generator	Both horizontal and vertical with shading level are adjustable via UART communication (Default: Disable)	
Still Image	Live video or freeze image is selectable via UART communication (Default: Live video)	N/A
Digital Zoom	Support	N/A
Communication	+3.3V UART communication via 3.5 Φ Stereo Jack (Baud rate: 115,200bps / 57,600bps / 38,400bps / 19,200bps / 9,600bps)	
Character Generator	Built-in character generation function via UART communication	
Defective Pixel Collection	Support	
Power	Input Voltage	+9 to +15 Vdc (Typical: +12 Vdc)
	Consumption	Less than 3.3 W
		Less than 2.1 W

Default: **Bold**

(*1) The longest exposure time is depending on video output mode

4.2 Spectral Sensitivity Characteristics

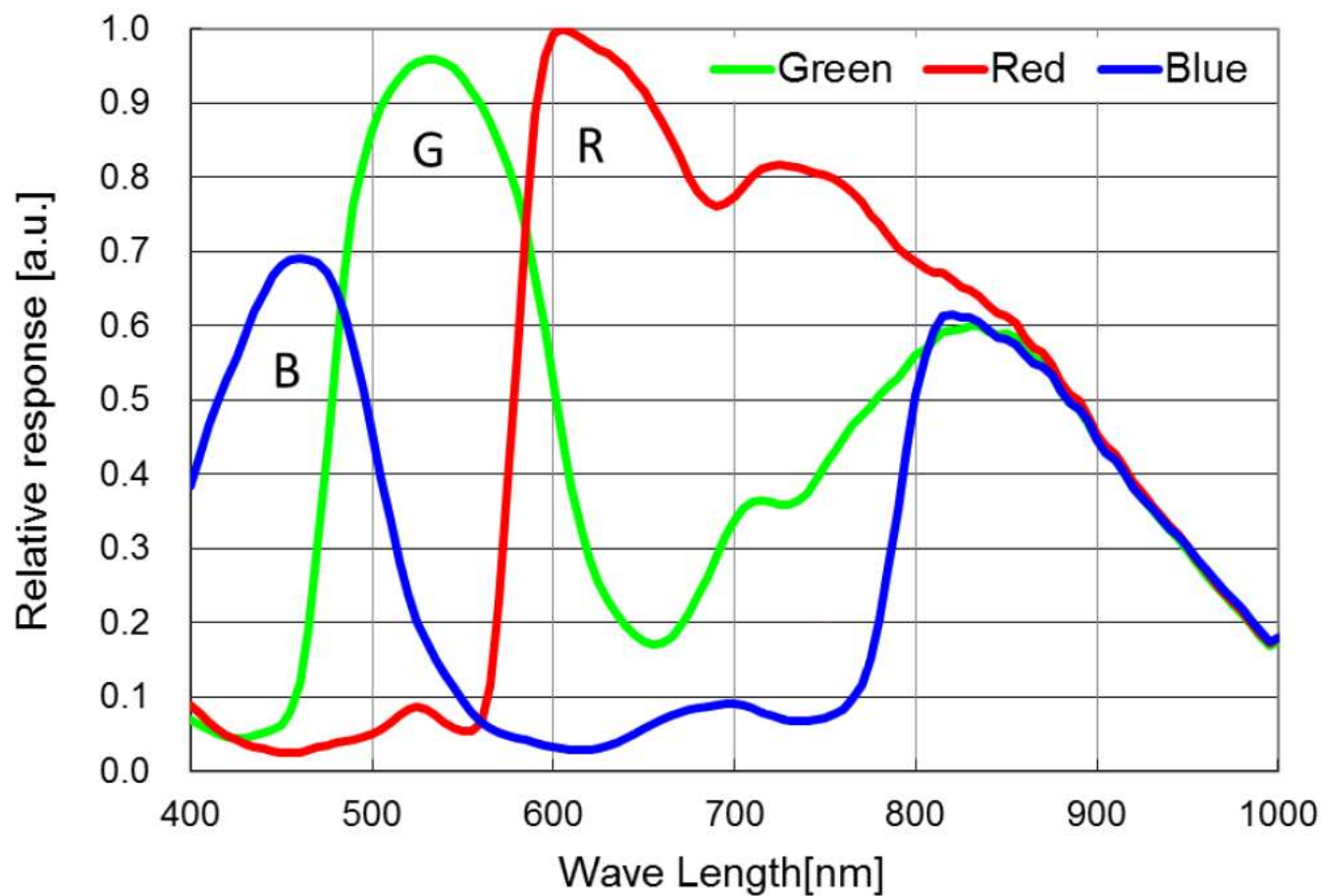

4.3 Mechanical Specifications

4.3.1 STC-HD213DV / STC-HD213DV-CS / STC-HD213DVN / STC-HD213DVN-CS

Model Number	STC-HD213DV / STC-HD213DVN	STC-HD213DV-CS / STC-HD213DVN-CS
Dimensions	40 (W) x 40 (H) x 48.9 (D) mm (*1)	40 (W) x 40 (H) x 43.9 (D) mm (*1)
Optical Filter	IR cut filter with OPLF	
Optical Center Accuracy	Positional accuracy in Horizontal and Vertical directions: +/- 0.3 mm Rotational accuracy of Horizontal and Vertical: +/- 1.5 deg.	
Material	Aluminum alloy (AC)	
Lens Mount (*2)	C Mount	CS Mount
Connectors	Video Output Connector: HDMI Connector Power Input Connector: DC power jack [PC721A (Switchcraft)](*3) Remote Control / UART Communication Connector: 3.5Φ Stereo Jack	
Camera Mount Screws	Two 1/4" Tripod screw holes: (One on top and bottom plate) Eight M4 screws holes: (Four on top and bottom plate)	
Weight	Approximately 129 g	Approximately 121 g

(*1) Excluding connectors

(*2) Recommend lens: More than F2.8 (Close side)

(*3) Please uses 2.1 mm plug for DC power plug.

762K (Switchcraft) or equivalent plug can be using for lock screw plug.

4.3.2 STC-HD213SDI / STC-HD213SDI-CS / STC-HD213SDIN / STC-HD213SDIN-CS

Model Number	STC-HD213SDI / STC-HD213SDIN	STC-HD213SDI-CS / STC-HD213SDIN-CS
Dimensions	40 (W) x 40 (H) x 48.9 (D) mm (*1)	40 (W) x 40 (H) x 43.9 (D) mm (*1)
Optical Filter	IR cut filter with OPLF	
Material	Aluminum alloy (AC)	
Lens Mount (*2)	C Mount	CS Mount
Connectors	Video Output Connector: BNC Connector Power Input Connector: DC power jack [PC721A (Switchcraft)] (*3) Remote Control / UART Communication Connector: 3.5Φ Stereo Jack	
Camera Mount Screws	Two 1/4" Tripod screw holes: (One on top and bottom plate) Eight M4 screws holes: (Four on top and bottom plate)	
Weight	Approximately 138 g	Approximately 130 g

(*1) Excluding connectors

(*2) Recommend lens: More than F2.8 (Close side)

(*3) Please uses 2.1 mm plug for DC power plug

762K (Switchcraft) or equivalent plug can be using for lock screw plug.

4.4 Environmental Specifications

4.4.1 STC-HD213DV / STC-HD213DV-CS / STC-HD213SDI / STC-HD213SDI-CS

Model Number	STC-HD213DV / STC-HD213DV-CS	STC-HD213SDI / STC-HD213SDI-CS
Operational Temperature / Humidity	Environmental Temperature: 0 to +40 deg. C, Environmental Humidity: 0 to 85 %RH (No condensation)	Environmental Temperature: 0 to +43 deg. C, Environmental Humidity: 0 to 85 %RH (No condensation)
Storage Temperature / Humidity	Environmental Temperature: -25 to +65 deg. C, Environmental Humidity: 0 to 85 %RH (No condensation)	
Vibration	20 Hz to 200 Hz to 20 Hz (5 min. / cycle), acceleration 10 G, XYZ 3 directions 30 min. each	
Shock	Acceleration 38 G, half amplitude 6 mseconds, XYZ 3 directions 3 times each	
Standard Compliancy	EMS: EN61000-6-2, EMI: EN55011 (Class A)	
RoHS	RoHS compliance	

4.4.2 STC-HD213DVN / STC-HD213DVN-CS / STC-HD213SDIN / STC-HD213SDIN-CS

Model Number	STC-HD213DVN / STC-HD213DVN-CS	STC-HD213SDIN / STC-HD213SDIN-CS
Operational Temperature / Humidity	Environmental Temperature: 0 to +48 deg. C, Environmental Humidity: 0 to 85 %RH (No condensation)	Environmental Temperature: 0 to +49 deg. C, Environmental Humidity: 0 to 85 %RH (No condensation)
Storage Temperature / Humidity	Environmental Temperature: -25 to +65 deg. C, Environmental Humidity: 0 to 85 %RH (No condensation)	
Vibration	20 Hz to 200 Hz to 20 Hz (5 min. / cycle), acceleration 10 G, XYZ 3 directions 30 min. each	
Shock	Acceleration 38 G, half amplitude 6 mseconds, XYZ 3 directions 3 times each	
Standard Compliancy	EMS: EN61000-6-2, EMI: EN55011 (Class A)	
RoHS	RoHS compliance	

4.5 External Control Specification

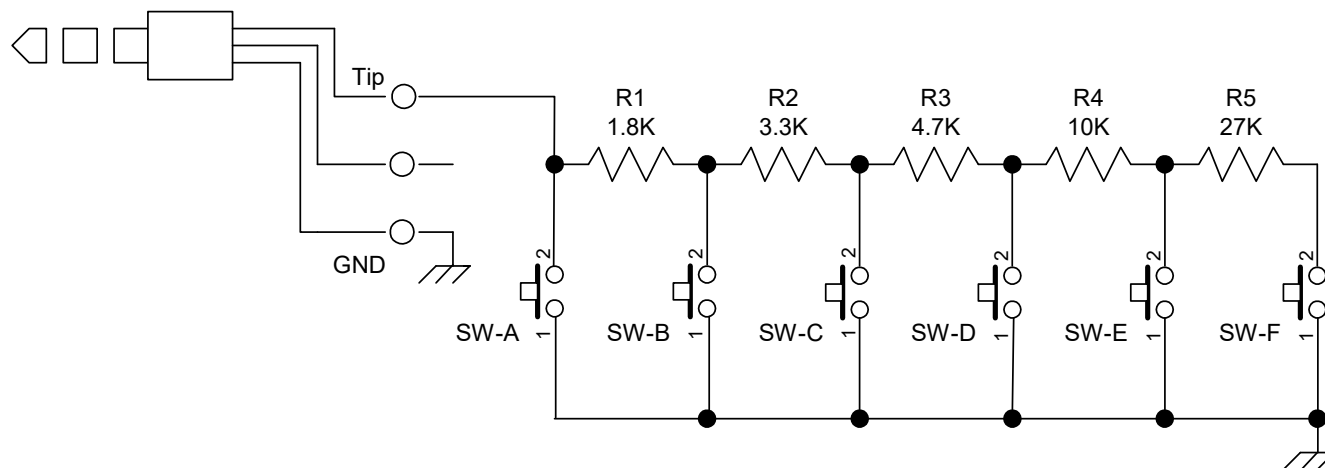
Circuit Diagram of SW Board to connect 3.5 ϕ Stereo Pin Jack

5 Dimensions

5.1 STC-HD213DV / STC-HD213DVN

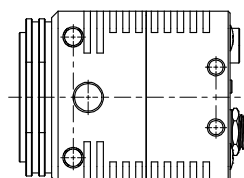
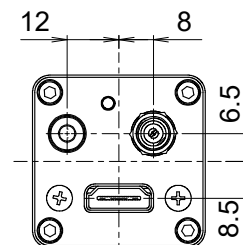
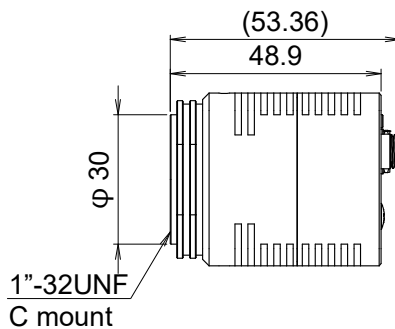
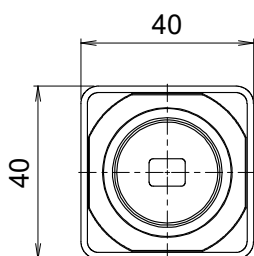
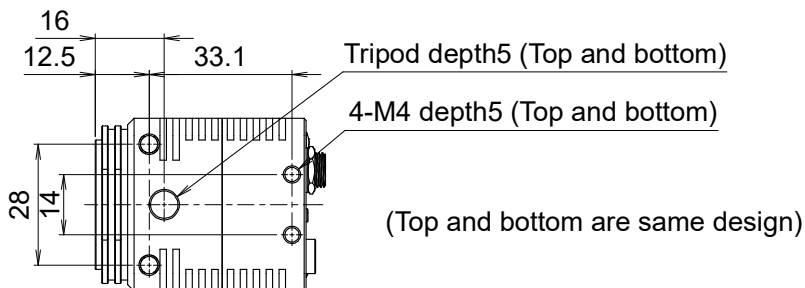
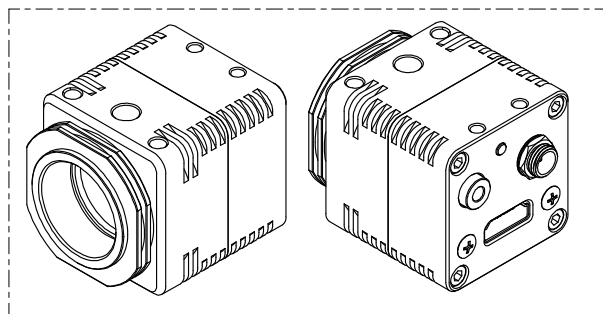

unit: mm

5.2 STC-HD213DV-CS / STC-HD213DVN-CS

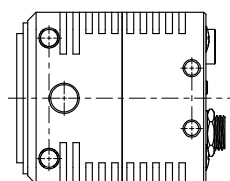
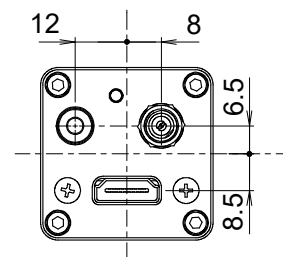
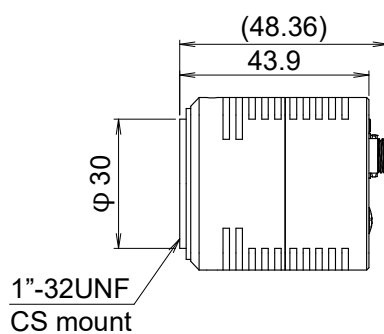
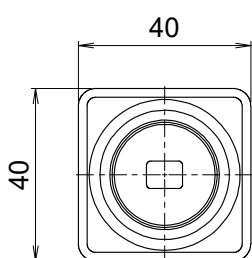
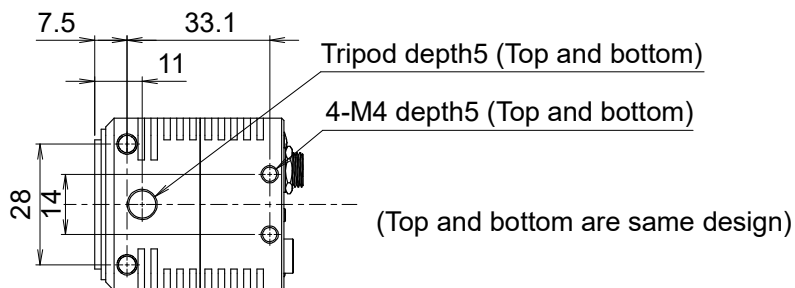
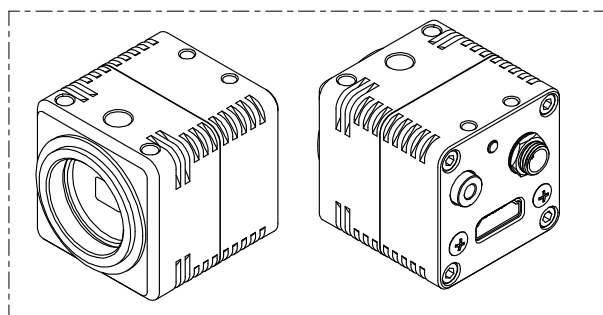

unit: mm



5.3 STC-HD213SDI / STC-HD213SDIN

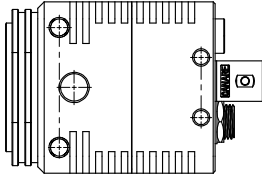
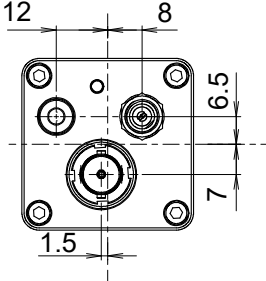
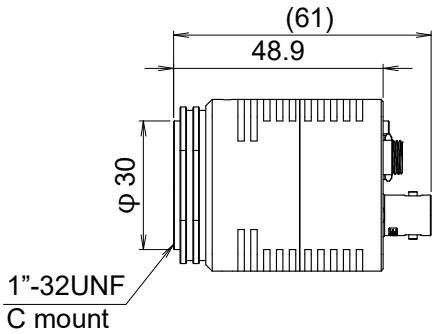
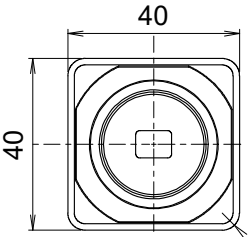
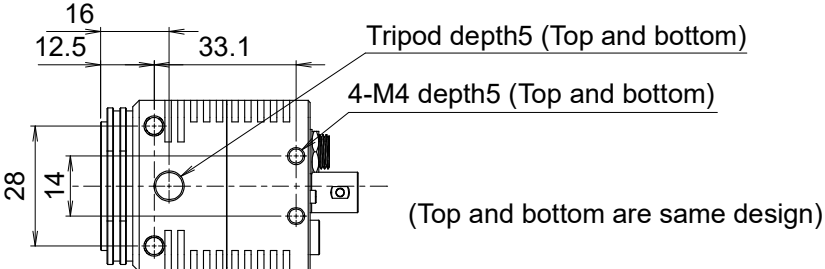
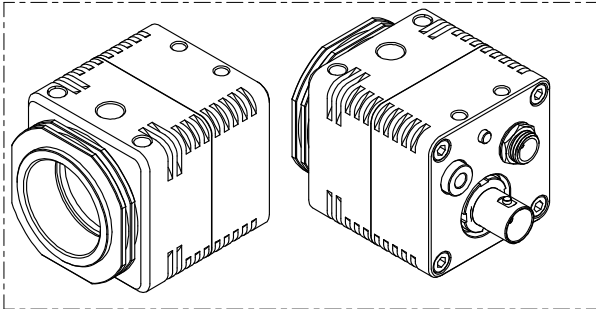

unit: mm



5.4 STC-HD213SDI-CS / STC-HD213SDIN-CS

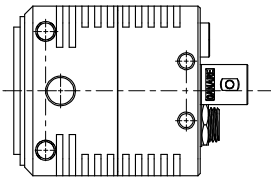
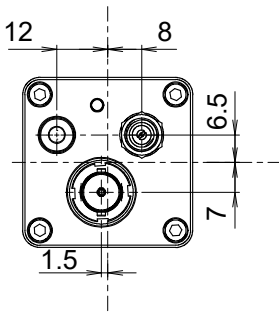
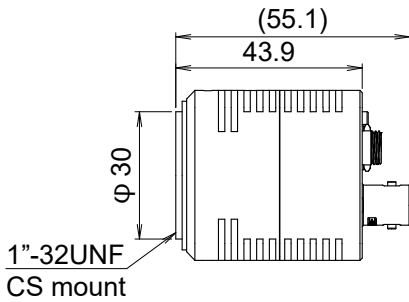
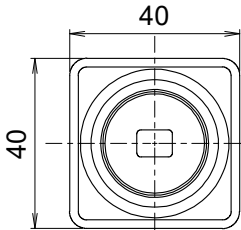
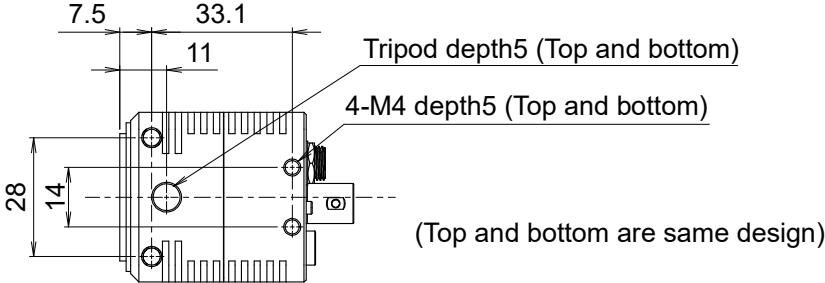
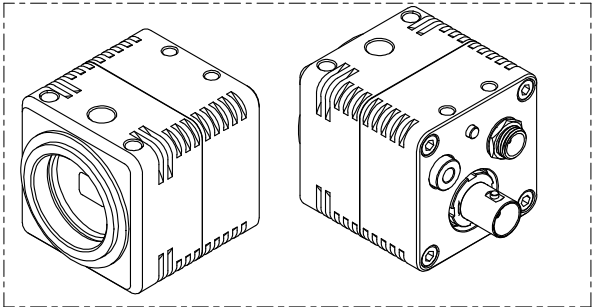

unit: mm

6 Camera instruction guide

This camera can be set through three setting settings as follows.

- A. Push Button
- B. External Switch (Remote controller: RC-HD133) *option
- C. Through the control software *as for detail, please refer to [another chapter](#)

6.1 Push Button

White Balance can be set through push button. (*1)

Single Push: Push to set White Balance
Hold: Auto White Balance

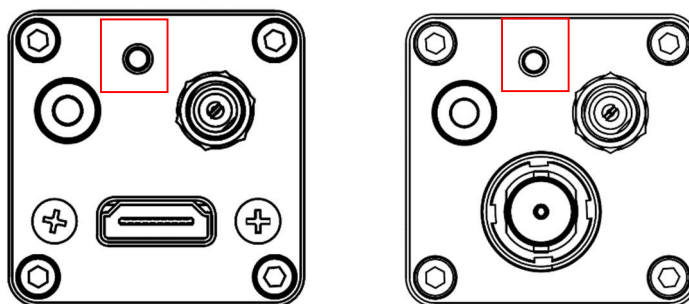

The location of Push button for each model

(*1) This push button can be assigned another function through communication

6.2 Camera Setting through External Switch (Remote Controller)

Remote controller (Model:RC-HD133) is option, remote controller is not included camera

6.2.1 Camera Setting through Switch that has 3.5 ϕ Stereo Pin Jack

A. Please assign each function through control software in advance

B. Connector

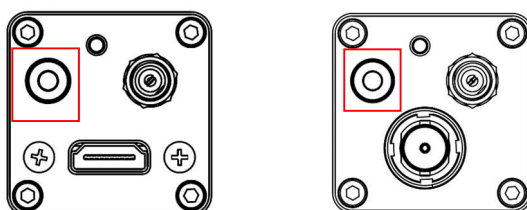

The location of 3.5 ϕ Stereo Pin Jack for each model

C. Switch Circuit Diagram,

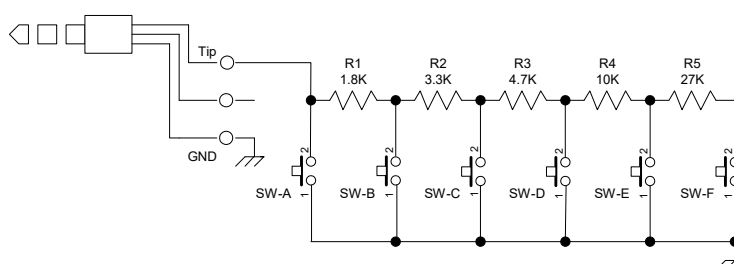

D. Example

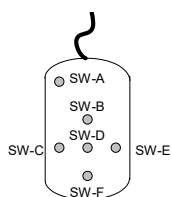

E. Switch Function

The button from SW-A to SW-F can be assigned as follow functions.

- SW-A: Show OSD Menu
- SW-B: Up Cursor (Menu and Select Setting)
- SW-C: Left Cursor (Select Setting)
- SW-D: Execute
- SW-E: Right Cursor (Select Setting)
- SW-F: Down Cursor (Menu and Select Setting)

6.2.2 Menu on screen with External Switch

Page 1

PAGE 1	2	3	4	5	6
ALC				ON	
LUMINANCE			110		
AGC				ON	
AEE				ON	
GAIN					
SHUTTER					
GAMMA					MANUAL

1) **ALC**

Selects enable / disable for auto exposing and auto gain (AGC) operation from below two selections. (Default: ON).

a) ON

The auto exposing and auto gain (AGC) operation.

The brightness of image will be maintaining to keep target brightness of image (with LUMINANCE setting) with auto exposing and auto gain functions.

b) OFF

The manual exposing and manual gain operation

“AGC” and “AEE” switch to “OFF (FIXED)” then adjusts with “GAIN” and “SHUTTER”.

2) **LUMINANCE**

Sets the target Brightness for auto exposing and auto gain operation.

The brightness of image will be maintaining with auto exposing and/or auto gain functions.

Setting range: 0 (Dark) to 255 (Bright)

Default: 110

3) **AGC**

Selects gain operation from below to gain operations. (Default: AUTO)

This setting is valid when selecting “ON” at “ALC”.

a) AUTO

The brightness of image will be maintaining to keep target brightness of image (with LUMINANCE setting) with auto gain function.

b) FIXED

The fixed gain operation

The fixed gain is adjustable with “GAIN”.

4) **AEE**

Selects exposing operation from below two exposing operations. (Default: AUTO)
The setting is valid when selecting "ON" at "ALC".

a) AUTO

The brightness of image will be maintaining to keep target brightness of image (with LUMINANCE setting) with auto exposing function.

b) FIXED

The fixed exposure time operation
The fixed exposure time is adjustable with "SHUTTER".

5) **GAIN**

Sets the fixed gain.

This fixed gain setting is valid when selecting "OFF" at "ALC", or "FIXED" at "AGC".
Setting range: 0 (0.00 dB) to 150 (45.0 dB)

6) **SHUTTER**

Sets the fixed exposure time.

This fixed exposure time setting is valid when selecting "OFF" at "ALC", or "FIXED" at "AEE".

Setting range:

1080p60	-447 (2.12 sec.) to 0 (1/60.1 sec.) to +561 (1/33,750.0 sec.)
1080p59.94	-447 (2.12 sec.) to 0 (1/60.1 sec.) to +561 (1/33,750.0 sec.)
1080p50	-447 (2.54 sec.) to 0 (1/50.1 sec.) to +561 (1/28,125.0 sec.)
1080p30	-447 (4.23 sec.) to 0 (1/30.1 sec.) to +561 (1/16,875.0 sec.)
1080p29.97	-447 (4.23 sec.) to 0 (1/30.1 sec.) to +561 (1/16,875.0 sec.)
1080p25	-447 (5.08 sec.) to 0 (1/25.0 sec.) to +561 (1/14,062.5 sec.)
1080i60	-447 (2.12 sec.) to 0 (1/60.1 sec.) to +561 (1/33,750.0 sec.)
1080i59.94	-447 (2.12 sec.) to 0 (1/60.1 sec.) to +561 (1/33,750.0 sec.)
1080i50	-447 (2.54 sec.) to 0 (1/50.1 sec.) to +561 (1/28,125.0 sec.)
720p60	-447 (2.12 sec.) to 0 (1/60.1 sec.) to +561 (1/33,750.0 sec.)
720p59.94	-447 (2.12 sec.) to 0 (1/60.1 sec.) to +561 (1/33,750.0 sec.)
720p50	-447 (2.54 sec.) to 0 (1/50.1 sec.) to +561 (1/28,125.0 sec.)

* The setting range for "Non-memory types" (STC-HD213DVN, HD213DVN-CS, HD213SDIN and HD213SDIN-CS) is "from 0 to +561"

7) **GAMMA**

Sets the Gamma.

It is necessary to set manual gamma setting via UART communication.

Setting selection: MANUAL, 0.3, 0.45, 0.50, 0.60, 0.70, 0.80, 0.90 / 1.00

Default: MANUAL.

PAGE	1	2	3	4	5	6
WB MODE						AUTO
R GAIN						
B GAIN						
SHARPNESS			H03			V03
CORING						02

1) **WB MODE**

Selects the white balance mode from below two modes. (Default: AUTO).

a) AUTO

The auto white balance operation.

b) MANUAL

The manual white balance operation with adjustable “R GAIN” and “B GAIN”.

2) **R GAIN**

Sets the R gain for manual white balance.

This setting is valid when selecting “MANUAL” at “WB MODE”.

Setting range: 0 to 1,023

3) **B GAIN**

Sets the B gain for manual white balance.

This setting is valid when selecting “MANUAL” at “WB MODE”.

Setting range: 0 to 1,023

4) **SHARPNESS**

Sets the sharpness (Edge enhancement) of image.

a) H

Sets the horizontal sharpness.

Setting range: 00 (Soft) to 15 (Strong)

Default: 03

b) V

Sets the vertical sharpness.

Setting range: 00 (Soft) to 15 (Strong)

Default: 03

5) **CORING**

The noise level also emphasizes when using sharpness function.

The SN ratio deteriorate for other than edge parts is prevented by cutting signal level that smaller than this setting.

The image becomes soft image if this setting sets too large.

Setting range: 00 to 63

Default: 02

PAGE	1	2	3	4	5	6
GRAPHICS			ON			
LINE			ON			
LINE1			H POS 0000	SIZE 0000		
			COLOR BLACK			
			V POS 0000	SIZE 0000		
			COLOR BLACK			
LINE2			H POS 0000	SIZE 0000		
			COLOR BLACK			
			V POS 0000	SIZE 0000		
			COLOR BLACK			

1) GRAPHICS

Selects enable or disable for line makers, shadow mask and circle marker displaying. (Default: ON).
This setting is synchronizing with "GRAPHICS" on Page 4.

a) ON

The line markers, shadow mask and circle marker can be display.

Selects enable or disable "line makers" display at "LINE"

Selects enable or disable "shadow mask" display at "SHADOW" on page 4.

Selects enable or disable "circle marker" display at "CIRCLE" on page 4.

b) OFF

The line markers, shadow mask and circle marker do not display.

2) LINE

Selects enable or disable for Line markers display (Default: ON).

This setting is valid when selecting "ON" at "GRAPHICS".

a) ON

The line makers are displaying.

Sets the color, size (thickness) and position for individual line.

The line maker does not display if size (thickness) of line is "0" or position of line is "0000" even selecting "ON" at "LINE".

b) OFF

The line markers do not display.

3) **LINE1** (Horizontal line 1 maker and vertical line 1 maker settings)

Sets the color, size (thickness) and position for horizontal line marker 1 and vertical line marker 1.

a) H POS

Sets the position for horizontal line marker 1.

Setting range: 0 (Top) to 1,080 (Bottom)

Default: 0

b) H SIZE

Sets the size (thickness) for horizontal line marker 1.

Setting range: 0 (0 line, horizontal line marker 1 does not display) to 1,080 (1,080 lines)

Default: 0

c) H COLOR

Sets the color for horizontal line marker 1.

It is necessary to set USER0 to USER7 colors via UART communication.

Setting selection: BLACK / WHITE / RED / GREEN / BLUE / CYAN / MAGENTA / YELLOW /
USER0 / USER1 / USER2 / USER3 / USER4 / USER5 / USER6 / USER7

Default: BLACK

d) V POS

Sets the position for vertical line marker 1.

Setting range: 0 (Left end) to 1,920 (Right end)

Default: 0

e) V SIZE

Sets the size (thickness) for vertical line marker 1.

Setting range: 0 (0 pixel, vertical line marker 1 does not display) to 1,920 (1,920 pixels)

Default: 0

F) V COLOR

Sets the color for vertical line marker 1.

It is necessary to set USER0 to USER7 colors via UART communication.

Setting selection: BLACK / WHITE / RED / GREEN / BLUE / CYAN / MAGENTA / YELLOW /
USER0 / USER1 / USER2 / USER3 / USER4 / USER5 / USER6 / USER7

Default: BLACK

4) **LINE2** (Horizontal line 2 maker and vertical line 2 maker settings)

Sets the color, size (thickness) and position for horizontal line marker 2 and vertical line marker 2.

a) H POS

Sets the position for horizontal line marker 2.

Setting range: 0 (Top) to 1,080 (Bottom)

Default: 0

b) H SIZE

Sets the size (thickness) for horizontal line marker 2.

Setting range: 0 (0 line, horizontal line marker 2 does not display) to 1,080 (1,080 lines)

Default: 0

c) H COLOR

Sets the color for horizontal line 2.

It is necessary to set USER0 to USER7 colors via UART communication.

Setting selection: BLACK / WHITE / RED / GREEN / BLUE / CYAN / MAGENTA / YELLOW /
USER0 / USER1 / USER2 / USER3 / USER4 / USER5 / USER6 / USER7

Default: BLACK

d) V POS

Sets the position for vertical line marker 2.

Setting range: 0 (Left end) to 1,920 (Right end)

Default: 0

e) V SIZE

Sets the size (thickness) for vertical line marker 2

Setting range: 0 (0 pixel, vertical line marker 2 does not display) to 1,920 (1,920 pixels)

Default: 0

F) V COLOR

Sets the color for vertical line 2.

It is necessary to set USER0 to USER7 colors via UART communication.

Setting selection: BLACK / WHITE / RED / GREEN / BLUE / CYAN / MAGENTA / YELLOW /
USER0 / USER1 / USER2 / USER3 / USER4 / USER5 / USER6 / USER7

Default: BLACK

PAGE	1	2	3	4	5	6
GRAPHICS	ON					
SHADOW	ON	GRADE	000			
		H	T 0000	B	1020	
		V	L 0000	R	1280	
CIRCLE	ON					
		RADIUS	000	SIZE	000	
		H	POS 0960			
		V	POS 0540			
		COLOR	BLACK			

1) GRAPHICS

Selects enable or disable for line makers, shadow mask and circle marker displaying. (Default: ON).
This setting is synchronizing with "GRAPHICS" on Page 3.

a) ON

The line markers, shadow mask and circle marker can be display.
Selects enable or disable "line makers" display at "LINE" on page 3.
Selects enable or disable "shadow mask" display at "SHADOW".
Selects enable or disable "circle marker" display at "CIRCLE".

b) OFF

The line markers, shadow mask and circle marker do not display.

2) SHADOW

Selects enable or disable for Shadow mask display (Default: ON).
This setting is valid when selecting "ON" at "GRAPHICS".

a) ON

The shadow mask is displaying.
Sets the grade and position for shadow mask.

b) OFF

The shadow mask does not display.

2-1) GRADE

Sets the grade of shadow mask.
Setting range: 0 (100% transparent, no shadow mask and image is visible) to 255 (Back shadow mask and image is invisible)
Default: 0

2-2) SHADOW H T

Sets the height of shadow mask from top of image.

Setting range: 0 (Top) to 1,079 (Bottom)

Default: 0

2-3) SHADOW H B

Sets the height of shadow mask from bottom of image.

Setting range: 0 (Top) to 1,080 (Bottom)

Default: 0

2-4) SHADOW V L

Sets the width of shadow mask from left of image.

Setting range: 0 (Left) to 1,919 (Right)

Default: 0

2-5) SHADOW V R

Sets the width of shadow mask from right of image.

Setting range: 0 (Left) to 1,920 (Right)

Default: 0

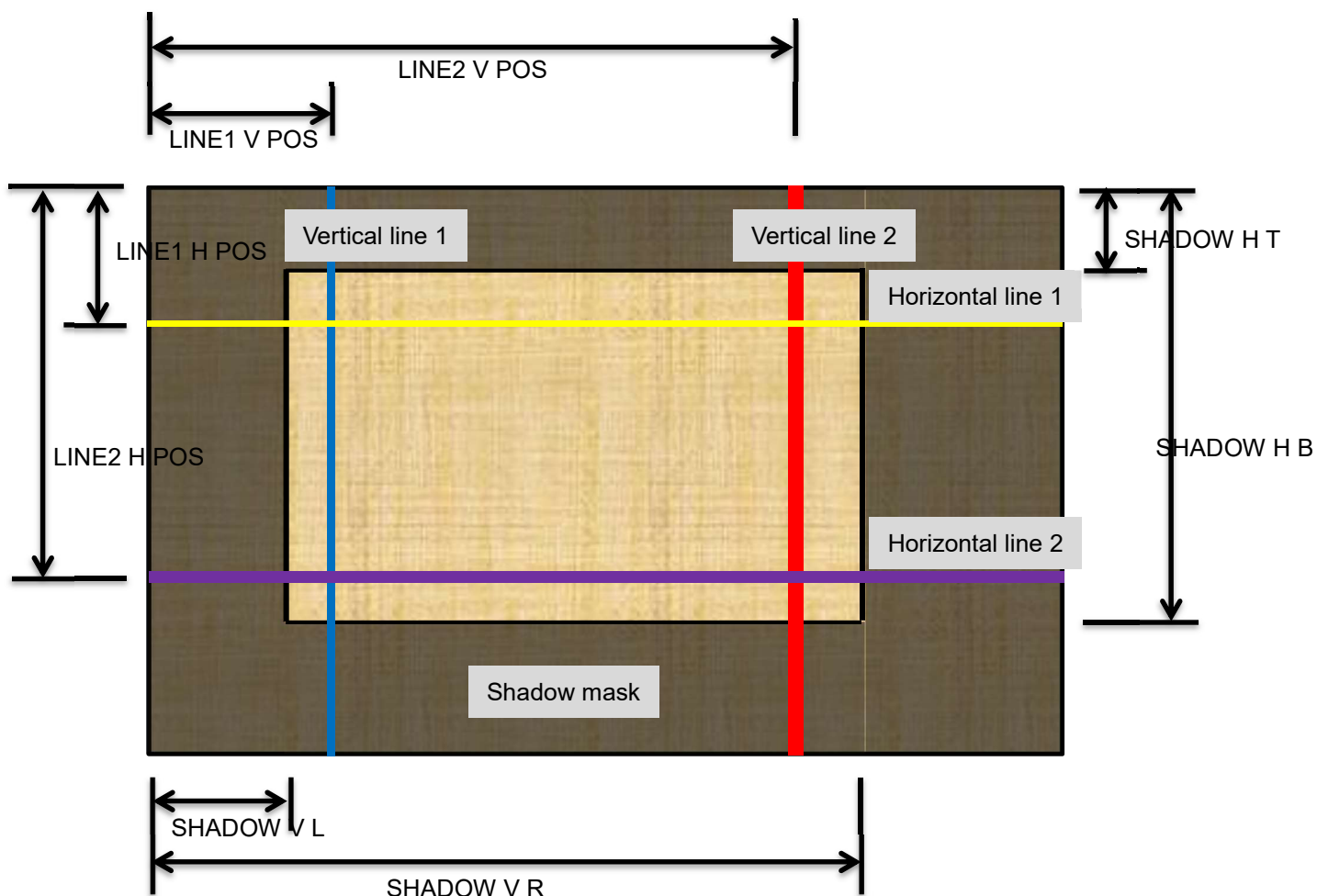

3) CIRCLE

Selects enable or disable for circle maker display (Default: ON).

This setting is valid when selecting "ON" at "GRAPHICS".

a) ON

The circle maker is displaying.

Sets the radius, line size (thickness), center position and color for circle maker.

The circle marker does not display if size (thickness) of circle is "0" even selecting "ON" at "CIRCLE".

b) OFF

The circle maker does not display.

3-1) RADIUS

Sets the radius for circle marker.

Setting range: 000 (Filled circle) to 960

Default: 000

3-2) SIZE

Sets the size (thickness) for circle marker.

Setting range: 0 (0, circle does not display) to 480

Default: 000

3-3) H POS

Sets the horizontal center position for circle marker.

Setting range: 000 (Left end) to 1,920 (Right end)

Default: 960

3-4) V POS

Sets the vertical center position for circle marker.

Setting range: 000 (Top) to 1,080 (Bottom)

Default: 540

3-5) COLOR

Sets the color for circle.

It is necessary to set USER0 to USER7 colors via UART communication.

Setting selection: BLACK / WHITE / RED / GREEN / BLUE / CYAN / MAGENTA / YELLOW /
USER0 / USER1 / USER2 / USER3 / USER4 / USER5 / USER6 / USER7

Default: BLACK

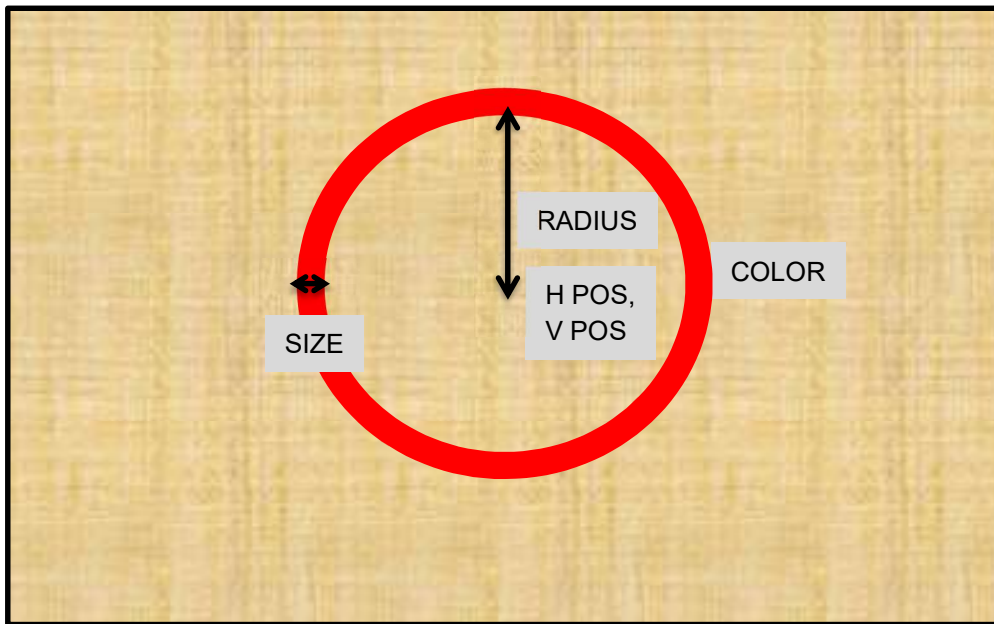

PAGE 1 2 3 4 5 6	
RES / FPS	AUTO
OSD SIZE	LARGE
PROFILES	PRESET0
PATTERNS	OFF
IMAGE OUTPUT	STANDARD
OUTPUT RANGE	FULL

1) RES / FPS

Sets the video format and frame rate for video output from below twelve output formats for DVI output models, eleven output format for SDI output models.

Please selects the video output format and frame rate to match specifications of monitor or capture devices.

If the monitor or capture devices does NOT support default setting, please selects video output format and frame rate with PC communication.

Setting selection: 1080p60 / 1080p59.94 / 1080p50 / 1080p30 / 1080p25 / 1080i60 / 1080i59.94 / 1080i50 / 720p60 / 720p59.94 / 720p50 / AUTO

* AUTO is only available for DVI output models.

When selecting "AUTO", camera checks supported resolution and frequency of monitor then camera switches to monitor supported maximum resolution and frequency automatically.

Default: AUTO (DVI output models)

1080i59.94 (SDI output models)

2) OSD SIZE

Sets the character size of OSD (Default: LARGE).

a) LARGE

OSD display with large size of character.

b) SMALL

OSD display with small size of character.

3) PROFILE

Preset data (from PRESET0 to PRESET7) can be apply to camera. (Default: PRESET0)

4) PATTERNS

Selects the output signal (video and test pattern) from below four output signals.
(Default: OFF (Vide output))

a) OFF

The video is output from camera.

b) GRAY

The gray scale test pattern is output from camera.

c) COLOR

The color test pattern is output from camera.

d) GRAY+COLOR

The color pattern (Top) + gray scale (Bottom) test pattern is output from camera.



GRAY



COLOR



GRAY+COLOR

5) IMAGE OUTPUT

Selects the flip image setting for video output from below four flip modes.
This setting does not apply to test pattern outputs.

a) STANDARD

The normal image (no-flip).

b) INVERSION

The horizontal flipped image.

c) V INVERSION

The vertical flipped image.

d) HV INVERSION

The horizontal and vertical flip (180-degree rotate) image.

6) OUTPUT RANGE

Some monitor is only displaying "16 to 235" gradation image through HDMI input even camera output "0 to 255" gradation image.

When selecting "LIMITED" at "OUPUT RANGE", output image from camera is "16 to 235" gradation image.

a) FULL

"0 to 255" full gradation image output from camera.

b) LIMITED

"16 to 235" limited gradation image output from camera.

Page 6

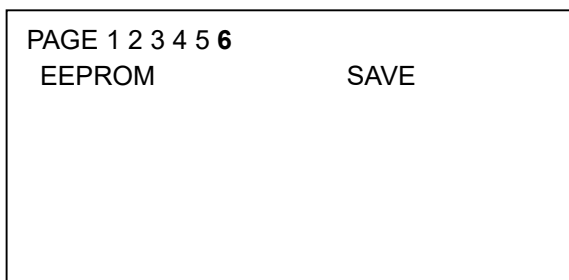

1) EEPROM

The camera settings in page1 to page5 can be saving into camera as default settings.

1-1) SAVE

When executing "SAVE", confirmation message "ARE YOU OK?" is displayed.

When executing again, the settings save into camera.

The message "COMPLETE" is displayed after settings are saved.

When selecting other than "executing" while "ARE YOU OK?" message is displaying, data save process is cancelled.

The data saves as profile data that is displaying at "PROFILES".

OSD SIZE and PATTERNS settings cannot be saved.

1-2) RESET

When executing "RESET", confirmation message "ARE YOU OK?" is displayed.

When executing again, all settings put back to factory default settings.

The message "COMPLETE" is displayed. The settings put back to factory default settings after reboot camera.

When selecting other than "executing" while "ARE YOU OK?" message is displaying, data reset process is cancelled.

Note: All settings of camera including PROFILE data put back to facture default setting when execute RESET.

7 Control Software User's Guide

7.1 System Requirements

+12V DC Power Supply: UN310-1210

Communication Tool (Communicate through USB port on PC): JIG-USB-HD

Control Software: JTBCtrl

7.2 Basic Operating Procedure

Connects the power supply with camera, and connect Communication Tool with PC via USB cable after installing JTBCtrl, control software can be launched from JTACtrl.exe.

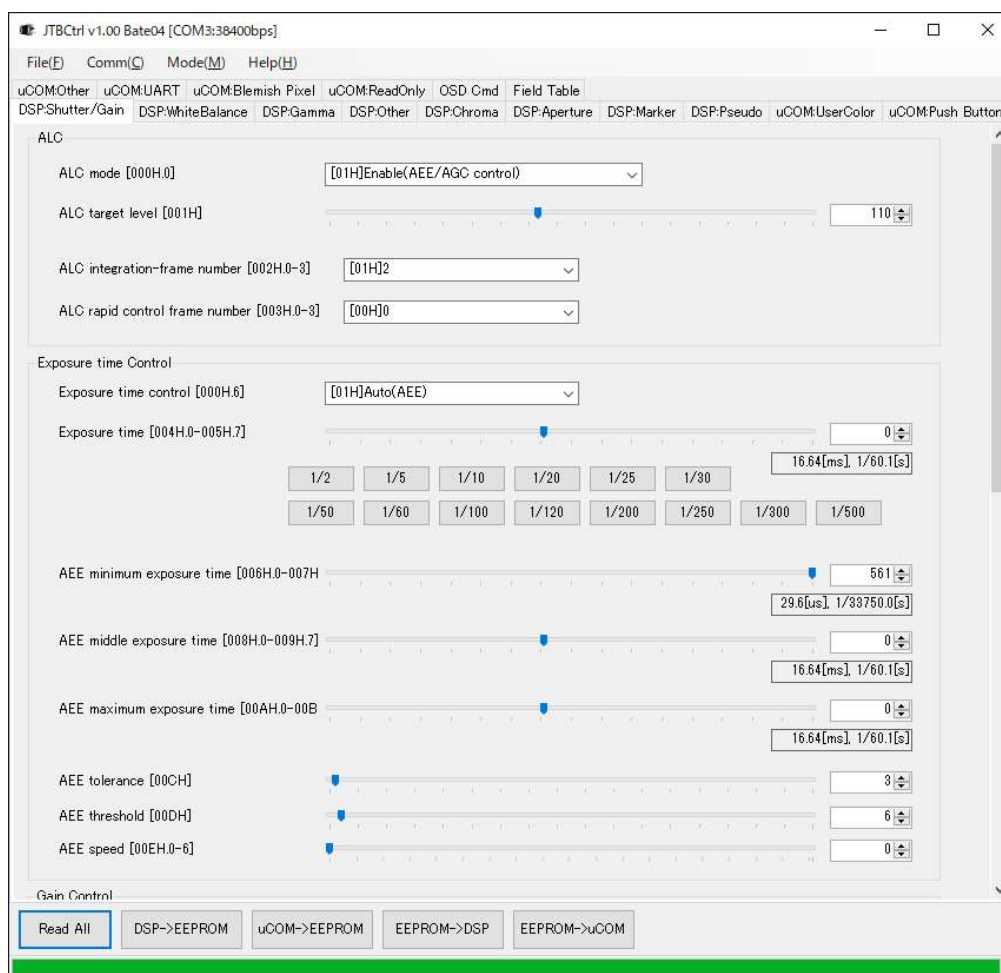

Select the COM port number through Comm(C) => Port Setting

Click Read All to read all of register values from camera.

All of camera setting can be configurable through control software.

7.3 Button Description



Read All

Read out All of DPS register and uCOM register settings on camera.
Please execute this button when turning on camera every time.

DSP -> EEPROM

Save the DSP register settings (that settings are on DSP tab) into EEPROM.

uCOM -> EEPROM

Save the uCOM register settings (that settings are on uCOM tab) into EEPROM.

EEPROM -> DSP

Read the DSP register settings on EEPROM.

EEPROM -> uCOM

Read the uCOM register settings on EEPROM.

7.4 The Differences of uCOM register and DSP register

Mainly video control functions are in DSP register area.

The communication settings and other functions as button setting are in uCOM register.

DSP has the eight User presets and user can configure each DSP Preset for each application.

7.5 Functional Description

DSP: Shutter/GainTab

The settings for exposing and gain are changeable. These can be change individual DSP User Preset.

ALC

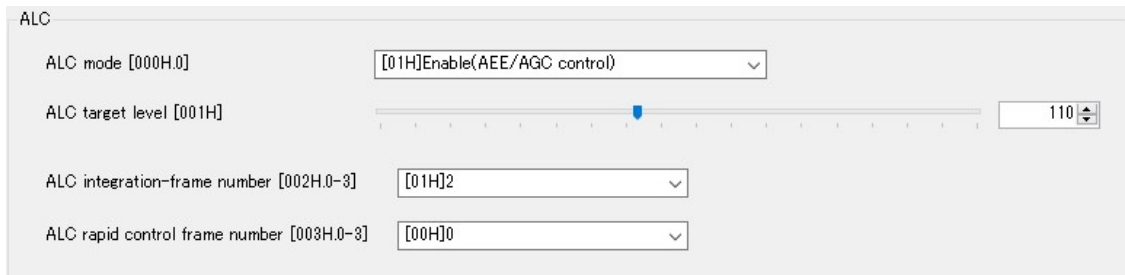

ALC

ALC mode [000H.0] [01H]Enable(AEE/AGC control)

ALC target level [001H] 110

ALC integration-frame number [002H.0-3] [01H]2

ALC rapid control frame number [003H.0-3] [00H]0

1) ALC mode

Selects enable or disable for ALC mode.

When selecting “Enable”, please set “Exposure time control”, “Gain control” and below control settings for ALC mode.

2) ALC target level

Sets the target brightness of image that is maintaining by auto exposing and/or auto gain operation.

3) ALC integration-frame number

Sets the number of frames to ALC process. (ALC processing speed)

4) ALC rapid control frame number

Sets the number of frames for rapid ALC processing when power on camera or changes displaying mode. (ALC processing speed when power on camera or changes displaying mode)

Exposure time control

Exposure time Control

Exposure time control [000H.6] [01H]Auto(AEE)

Exposure time [004H.0-005H.7] 0

1/2 1/5 1/10 1/20 1/25 1/30 16.64[ms], 1/60.1[s]

1/50 1/60 1/100 1/120 1/200 1/250 1/300 1/500

AEE minimum exposure time [006H.0-007H] 561

29.6[us], 1/33750.0[s]

AEE middle exposure time [008H.0-009H.7] 0

16.64[ms], 1/60.1[s]

AEE maximum exposure time [00AH.0-00B] 0

16.64[ms], 1/60.1[s]

AEE tolerance [00CH] 3

AEE threshold [00DH] 6

AEE speed [00EH.0-6] 0

1) Exposure time control

Selects exposing control method from “Fixed exposure time” and “Auto exposing (AEE)”.

2) Exposure Time

Sets the exposure time for fixed exposure time control.

3) AEE minimum exposure time, AEE middle exposure time and AEE maximum exposure time

The exposure time for is changing automatically with these settings, based on brightness of object. It is necessary to set minimum, middle and maximum AEE exposure time as below order.

AEE minimum exposure time \leq AEE middle exposure time \leq AEE maximum exposure time

4) AEE tolerance

The AEE process will be stop when differences between “ALC target brightness” and current brightness becomes smaller than AEE tolerance.

5) AEE threshold

The AEE process will be start when differences between “ALC target brightness” and current brightness becomes greater than “(AEE tolerance + AEE threshold)”

6) AEE speed

The maximum amount of exposure time change for AEE control is limit by this setting.

Gain Control

Gain Control

Gain control [000H.7] [01H]Auto(AGC)

Gain value [010H] 100 [30.0[dB]]

AGC minimum gain [011H] 0 [0.0[dB]]

AGC middle gain [012H] 30 [9.0[dB]]

AGC maximum gain [013H] 100 [30.0[dB]]

AGC tolerance [014H] 3

AGC threshold [015H] 6

AGC speed [016H.0-4] 0

1) Gain control

Selects gain control method from “Fixed gain” and “Auto (AGC)”.

2) Gain value

Sets the gain for fixed gain control.

3) AGC minimum gain, AGC middle gain and AGC maximum gain

The gain for AGC is changing automatically with these settings, based on brightness of object. It is necessary to set minimum, middle and maximum AGC gain as below order.

AGC minimum gain \leq AGC middle gain \leq AGC maximum gain

4) AGC tolerance

The AGC process will be stop when differences between “ALC target brightness” and current brightness becomes smaller than AGC tolerance.

5) AGC threshold

The AGC process will be start when differences between “ALC target brightness” and current brightness becomes greater than “(AGC tolerance + AGC threshold)”

6) AGC speed

The maximum amount of gain change for AGC control is limit by this setting.

Weight Photometry

Weight Photometry

Photometry mode [080H.0] [00H]Average photometry

1	5	1
6	10	6
2	7	2

0frame coefficient [081H.0-3] 1

1frame coefficient [082H.0-3] 5

2frame coefficient [083H.0-3] 1

3frame coefficient [084H.0-3] 6

4frame coefficient [085H.0-3] 10

5frame coefficient [086H.0-3] 6

6frame coefficient [087H.0-3] 2

7frame coefficient [088H.0-3] 7

8frame coefficient [089H.0-3] 2

1) Photometry mode

Selects photometry mode for ALC control from “Average photometry” and “Weight photometry”.
 When selecting “Average photometry” same weight is applying for all nine frames.
 When selecting “Weight photometry”, individual weight is applying for each frame.

DSP: WhiteBalance

The settings for white balance are changeable. These can be change individual DSP User Preset.

White Balance

White balance mode [020H.0] [01H]Auto(AWB)

Pull-in limit in auto white balance mode [020H.1] [01H]Enable

White balance R gain [022H.0-023H.1] 481

White balance G gain [024H.0-025H.1] 0

White balance B gain [026H.0-027H.1] 169

AWB integration-frame number [030H.0-3] [01H]2

AWB rapid control frame number [031H.0-3] [00H]0

1) White balance mode

Selects the white balance mode from “Manual” and “Auto (AWB)”

“Manual” mode is white balance process with manual white balance gain “White balance R gain” and “White balance B gain”.

“Auto (AWB)” mode is white balance gain is adjusting automatically.

2) Pull-in limit in auto white balance mode

Selects enable or disable pull-in limit for R and B for AWB mode.

3) White balance R gain

Sets R gain for manual white balance mode.

This setting is valid when selecting “Manual” at white balance mode.

4) White balance G gain

Sets G gain for white balance mode.

This setting is valid for both white balance mode.

5) White balance B gain

Sets B gain for manual white balance mode.

This setting is valid when selecting “Manual” at white balance mode.

6) AWB integration-frame number

Sets the number of frames to AWB process. (AWB processing speed)

7) AWB rapid control frame number

Sets the number of frames for rapid AWB processing when power on camera or changes displaying mode.

(AWB processing speed when power on camera or changes displaying mode)

AWB (Limited gain)

AWB (Limited gain)

R gain reference level of low color temperature direction [034H.0-035H.1]

B gain reference level of low color temperature direction [036H.0-037H.1]

R gain reference level of middle color temperature direction [038H.0-039H.1]

B gain reference level of middle color temperature direction [03AH.0-03BH.1]

R gain reference level of high color temperature direction [03CH.0-03DH.1]

B gain reference level of high color temperature direction [03EH.0-03FH.1]

B gain

R gain

R gain + frame for low color temperature direction [044H]

R gain - frame for low color temperature direction [045H]

B gain + frame for low color temperature direction [046H]

B gain - frame for low color temperature direction [047H]

R gain + frame for middle color temperature direction [048H]

R gain - frame for middle color temperature direction [049H]

B gain + frame for middle color temperature direction [04AH]

B gain - frame for middle color temperature direction [04BH]

R gain + frame for high color temperature direction [04CH]

R gain - frame for high color temperature direction [04DH]

B gain + frame for high color temperature direction [04EH]

B gain - frame for high color temperature direction [04FH]

AWB tolerance(Pull-in limit) [040H]

AWB threshold(Pull-in limit) [041H]

AWB step divisor(Pull-in limit) [042H]

- 1) **R gain and B gain reference level of low color temperature**
Sets the R and B gain reference level for low color temperature of AWB control.
- 2) **R gain and B gain reference level of middle color temperature**
Sets the R and B gain reference level for middle color temperature of AWB control.
- 3) **R gain and B gain reference level of high color temperature**
Sets the R and B gain reference level for high color temperature of AWB control.
- 4) **R gain frame and B frame for low color temperature**
Sets the tolerance area (+ and - frame) of R and B gain for low color temperature of AWB control.
- 5) **R gain frame and B frame for middle color temperature**
Sets the tolerance area (+ and - frame) of R and B gain for middle color temperature of AWB control.
- 6) **R gain frame and B frame for high color temperature**
Sets the tolerance area (+ and - frame) of R and B gain for high color temperature of AWB control.
- 7) **AWB tolerance (pull-in limit)**
The pull-in limit AWB process will be stop when white balance error becomes smaller than AWB tolerance.
- 8) **AWB threshold (pull-in limit)**
The pull-in limit AWB process will be start when white balance error becomes greater than “(AWB tolerance + AWB threshold)”
- 9) **AWB step divisor (pull-in limit)**
Sets the step divisor of pull-in AWB process.

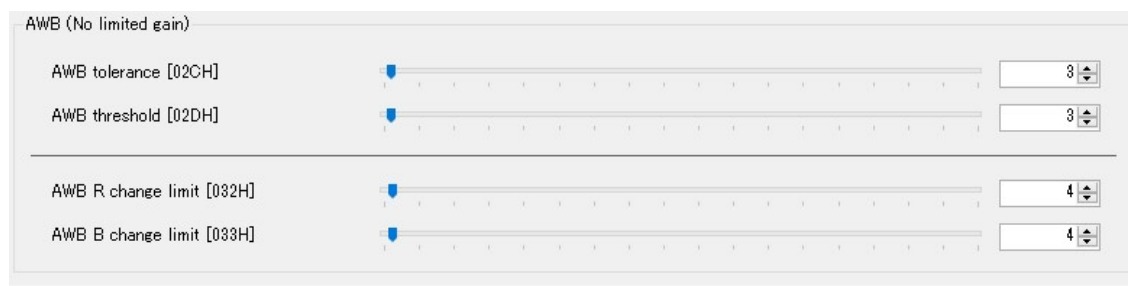

Parameter	Value
AWB tolerance [02CH]	3
AWB threshold [02DH]	3
AWB R change limit [032H]	4
AWB B change limit [033H]	4

- 1) **AWB tolerance (No limited gain)**
The no limited gain AWB process will be stop when white balance error becomes smaller than AWB tolerance.
- 2) **AWB threshold (No limited gain)**
The no limited gain AWB process will be start when white balance error becomes greater than “(AWB tolerance + AWB threshold)”
- 3) **AWB R and B change limit**
Sets the control speed for no limit gain AWB process.
The maximum amount of white balance gain change is limit by this setting. (There is no limit when setting “0”)

DSP: Gamma

The settings for gamma are changeable. These can be change individual DSP User Preset.

Gamma

Gamma	
Gamma mode [063H.7]	[01H]Manual
Preset gamma [063H.0-3]	[04H]0.6

1) Gamma mode

Selects the gamma mode from “Preset” and “Manual”.

When selecting “Preset” gamma mode, gamma control with selected preset gamma at “Preset gamma” is valid.

When selecting “Manual” gamma mode, gamma control with gamma control point settings.

2) Preset gamma

Selects the preset gamma mode from “1.0”, “0.9”, “0.8”, “0.7”, “0.6”, “0.5”, “0.45”, “0.3” and “Through”.

This setting is valid when selecting “Preset” at “Gamma mode”.

Manual Gamma

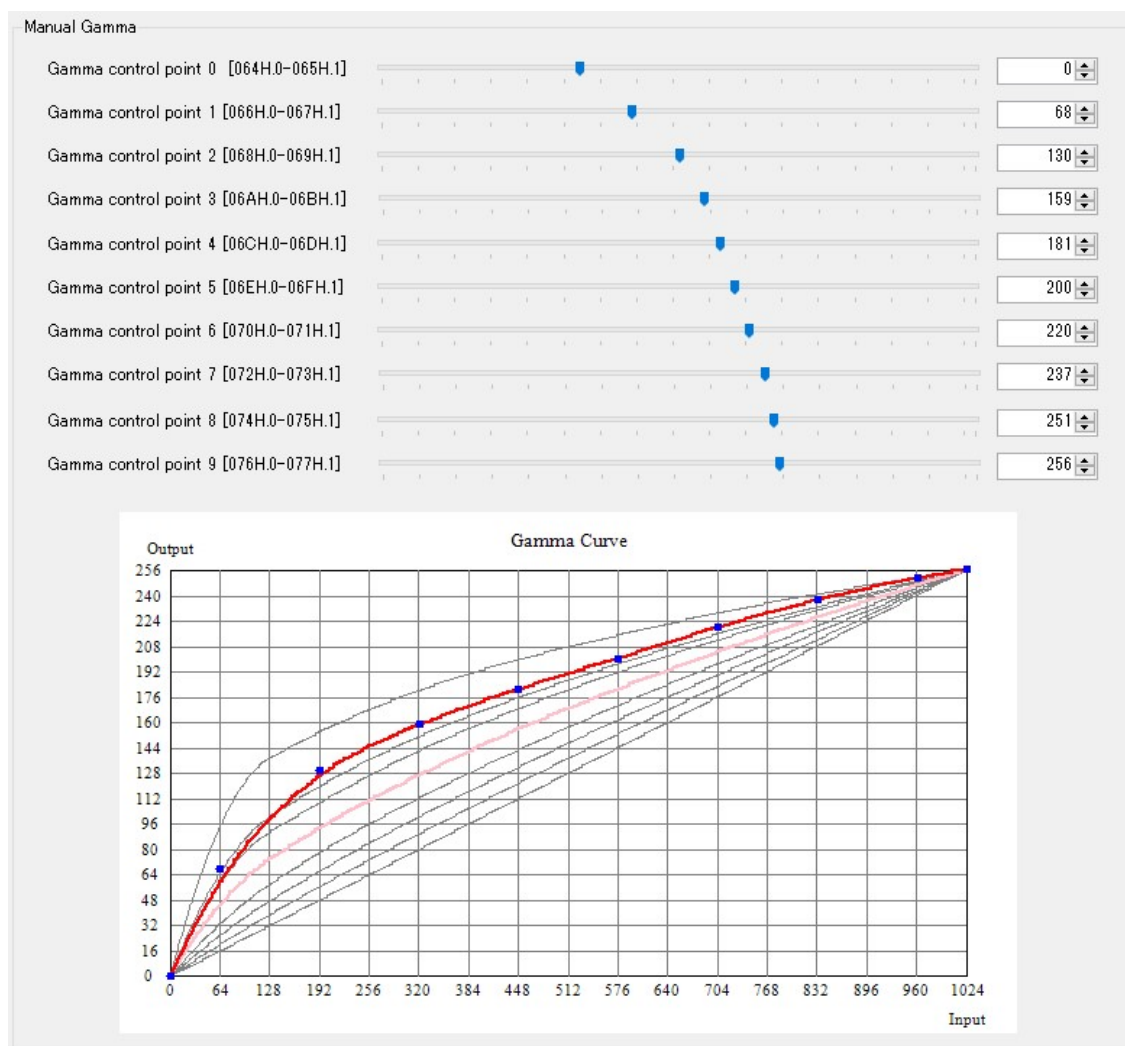

1) Gamma control point 0 to 9

It is necessary to adjust gamma control point with displaying "Gamma Curve".
These settings are valid when selecting "Manual" at "Gamma mode".

DSP: Other

The settings for “Resolution and frame rate”, flip image and “Color / Monochrome” are changeable. These can be change individual DSP User Preset.

DSP Other

DSP Other	
Resolution/FrameRate [060H.0-3]	[0CH]Auto
Horizontal flip [061H.0]	[00H]OFF
Vertical flip [061H.1]	[00H]OFF
Color/Black and white [141H.7]	[00H]Color

1) Resolution/FrameRate

Selects the video output format from “1080p 60fps”, “1080p 59.94fps”, “1080p 50fps”, “1080p 30fps”, “1080p 29.97fps”, “1080i 60fps”, “1080i 59.94fps”, “1080i 50fps”, “720p 60fps”, “720p 59.94fps” and “720p 50fps”.

* “Auto” is only available for DVI output models.

When selecting “Auto”, camera checks supported resolution and frequency of monitor then camera switches to monitor supported maximum resolution and frequency automatically.

2) Horizontal flip

Selects “OFF” or “ON” for horizontal flip video output.

When selecting “OFF”, standard video is output from camera.

When selecting “ON”, horizontal flipped video is output from camera.

3) Vertical flip

Selects “OFF” or “ON” for vertical flip video output.

When selecting “OFF”, standard video is output from camera.

When selecting “ON”, vertical flipped video is output from camera.

4) Color/Black and white

Selects the video output from “Color” and “Black and white”.

When selecting “Color”, color video is output from camera.

When selecting “Black and white”, monochrome video is output from camera.

DSP: Chroma

The settings for color (gain / saturation, and hue) are changeable. These can be change individual DSP User Preset.

YUV

YUV

R-Y Gain [142H.0-6] 28

R-Y Hue [144H] -12

B-Y Gain [143H.0-6] 28

B-Y Hue [145H] -29

1) R-Y Gain and B-Y Gain

Sets gain (saturation) of color with “R-Y Gain” and “B-Y Gain”.

2) R-Y Hue and B-Y Hue

Sets hue of color with “R-Y Hue” and “B-Y Hue”.

High luminance chroma suppress

High luminance chroma suppress

High luminance chroma suppress threshold [146H] 240

High luminance chroma suppress slope [147H.0-3] 1

1) High luminance chroma suppress threshold and slope

These settings are help to eliminate false color at high luminance part of video.

DSP: Aperture

The settings for aperture (edge enhancement) are changeable. These can be change individual DSP User Preset.

Aperture



Parameter	Slider Position	Value 1	Value 2
Aperture H. gain [148H.0-3]	Mid-right	3	0.38
Aperture V. gain [148H.4-7]	Mid-right	3	0.38
Aperture coring [149H.0-5]	Mid-left	2	

1) Aperture H Gain

Sets horizontal aperture gain.

When setting great value, horizontal edge enhancement becomes strong.

2) Aperture V Gain

Sets vertical aperture gain.

When setting great value, vertical edge enhancement becomes strong.

3) Aperture coring

The noise level also emphasizes when using aperture function.

The SN ratio deteriorate for other than edge parts is prevented by cutting signal level that smaller than this setting.

The image becomes soft image if this setting sets too large.

DSP: Marker

The settings for markers (line markers, shadow mask and circle marker) are changeable. These can be change individual DSP User Preset.

Marker

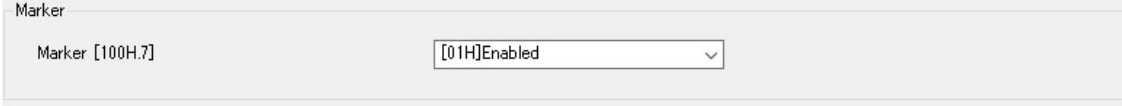

Marker

Marker [100H.7] [01H]Enabled

1) Marker

Selects enable or disable for displaying markers.

When selecting “Enable”, line markers, shadow mask and circle marker are displaying.

It is necessary to set color, thickness (size) and displaying position for each marker and shadow mask.

When selecting “Disable”, any markers including shadow mask do not display.

Line Marker

Line Marker

Line marker [100H.0]

Horizontal line1 marker color [10AH.4-7]

Horizontal line1 marker position [10CH.0-10DH.2]

Horizontal line1 marker thickness [10EH.0-10FH.2]

Vertical line1 marker color [10AH.0-3]

Vertical line1 marker position [110H.0-111H.2]

Vertical line1 marker thickness [112H.0-113H.2]

Horizontal line2 marker color [114H.4-7]

Horizontal line2 marker position [116H.0-117H.2]

Horizontal line2 marker thickness [118H.0-119H.2]

Vertical line2 marker color [114H.0-3]

Vertical line2 marker position [11AH.0-11BH.2]

Vertical line2 marker thickness [11CH.0-11DH.2]

1) Line marker

Selects enable or disable for displaying line markers.

When selecting "Enable", line markers are displaying.

It is necessary to set color, thickness (size) and displaying position for each line marker.

When selecting "Disable", any line markers do not display.

2) Horizontal line 1 maker color and Horizontal line 2 marker color

Selects color for horizontal line individually.

3) Horizontal line 1 maker position and Horizontal line 2 marker position

Sets displaying position (lines) for horizontal line individually.

When setting small value, horizontal line is displaying at upper part of image.

When setting great value, horizontal line is displaying at lower part of image.

4) Horizontal line 1 thickness and Horizontal line 2 marker thickness

Sets thickness (size) for horizontal line individually.

When selecting "0", horizontal line does not display.

When selecting small value, thin horizontal line is displaying.

When selecting great value, thick horizontal line is displaying.

5) Vertical line 1 maker color and Vertical line 2 marker color

Selects color for vertical line individually.

- 6) Vertical line 1 maker position and Vertical line 2 marker position**
Sets displaying position (pixels) for vertical line individually.
When setting small value, vertical line is displaying at right part of image.
When setting great value, vertical line is displaying at left part of image.
- 7) Vertical line 1 thickness and Vertical line 2 marker thickness**
Sets thickness (size) for vertical line individually.
When selecting “0”, vertical line does not display.
When selecting small value, thin vertical line is displaying.
When selecting great value, thick vertical line is displaying.

Shadow Mask

- 1) Shadow mask**
Selects enable or disable for displaying shadow mask.
When selecting “Enable”, shadow mask is displaying.
It is necessary to set shading level and areas for shadow mask.
When selecting “Disable”, shadow mask does not display.
- 2) Shadow mask shading level**
Sets shading level for shadow mask.
When setting 0, 100% transparent shadow mask and borders of shadow mask are displaying.
When setting 255, 100% black shadow mask is displaying.
- 3) Horizontal shadow mask top position**
Sets border of shadow mask from top of image.
- 4) Horizontal shadow mask bottom position**
Sets border of shadow mask from bottom of image.
- 5) Vertical shadow mask left position**
Sets border of shadow mask from left of image.
- 6) Vertical shadow mask right position**
Sets border of shadow mask from right of image.

Circle Marker

Circle Marker

Circle marker [100H.2]	[01H]Enabled	
Circle marker color [11EH.0-3]	[00H]Black	
Circle marker radius [120H.0-121H.2]	<input type="range" value="0"/>	0
Circle marker width [122H.0-123H.2]	<input type="range" value="0"/>	0
Circle marker Horizontal position [124H.0-125H.2]	<input type="range" value="960"/>	960
Circle marker Vertical position [126H.0-127H.2]	<input type="range" value="540"/>	540

1) Circle marker

Selects enable or disable for displaying circle marker.

When selecting “Enable”, circle marker is displaying.

It is necessary to set color, radius, thickness and displaying position for circle marker.

When selecting “Disable”, circle marker does not display.

2) Circle marker color

Selects color for circle marker.

3) Circle marker radius

Sets radius for circle marker.

4) Circle marker Horizontal position

Sets horizontal center position for circle marker.

5) Circle marker Vertical position

Sets vertical center position for circle marker.

DSP: Pseudo

The settings for Pseudo mode (color, threshold and slope) are changeable.
These can be change individual DSP User Preset.

Pseudo

Pseudo

Picture mode selection [128H.0]

Background pseudo color [129H.0-3] abc

Overlay graphics pseudo color [129H.4-7]

Normal color mode shadow mask line color [128H.1]

Pseudo color threshold [12AH]

Pseudo color slope [12BH]

1) Picture mode selection

Selects picture mode from “Normal” and “Pseudo”.
When selecting “Normal”, original image is output from camera.
When selecting “Pseudo”, pseudo image is output from camera.
It is necessary to set color, threshold and slope.

2) Background pseudo color

Selects color for background of pseudo image.

3) Overlay graphics pseudo color

Selects color for foreground of pseudo image.

4) Normal color mode shadow mask line color

Selects color of boarder of shadow mask from “Black” or pseudo color.

5) Pseudo color threshold

Sets threshold for banalization of pseudo image.

6) Pseudo color slope

Sets slope for banalization of pseudo image.

uCOM: UserColor

The settings for user defined color of makers are changeable.
These are applying all DSP User Presets.

Pseudo

User Defined Color			
User defined color 0 R [010H]	0	<input type="range"/>	<input type="text" value="255"/>
User defined color 0 G [011H]		<input type="range"/>	<input type="text" value="128"/>
User defined color 0 B [012H]		<input type="range"/>	<input type="text" value="0"/>
User defined color 1 R [013H]	1	<input type="range"/>	<input type="text" value="255"/>
User defined color 1 G [014H]		<input type="range"/>	<input type="text" value="0"/>
User defined color 1 B [015H]		<input type="range"/>	<input type="text" value="128"/>
User defined color 2 R [016H]	2	<input type="range"/>	<input type="text" value="128"/>
User defined color 2 G [017H]		<input type="range"/>	<input type="text" value="255"/>
User defined color 2 B [018H]		<input type="range"/>	<input type="text" value="0"/>
User defined color 3 R [019H]	3	<input type="range"/>	<input type="text" value="0"/>
User defined color 3 G [01AH]		<input type="range"/>	<input type="text" value="255"/>
User defined color 3 B [01BH]		<input type="range"/>	<input type="text" value="128"/>
User defined color 4 R [01CH]	4	<input type="range"/>	<input type="text" value="128"/>
User defined color 4 G [01DH]		<input type="range"/>	<input type="text" value="0"/>
User defined color 4 B [01EH]		<input type="range"/>	<input type="text" value="255"/>
User defined color 5 R [01FH]	5	<input type="range"/>	<input type="text" value="0"/>
User defined color 5 G [020H]		<input type="range"/>	<input type="text" value="128"/>
User defined color 5 B [021H]		<input type="range"/>	<input type="text" value="255"/>
User defined color 6 R [022H]	6	<input type="range"/>	<input type="text" value="128"/>
User defined color 6 G [023H]		<input type="range"/>	<input type="text" value="128"/>
User defined color 6 B [024H]		<input type="range"/>	<input type="text" value="128"/>
User defined color 7 R [025H]	7	<input type="range"/>	<input type="text" value="255"/>
User defined color 7 G [026H]		<input type="range"/>	<input type="text" value="207"/>
User defined color 7 B [027H]		<input type="range"/>	<input type="text" value="0"/>

1) User defined color 0 to 7

Sets R, G and B elements for user defined color individually.

uCOM: Push Button

The settings for push buttons are changeable.
These are applying all DSP User Presets.

Push Button

Push Button	
Push button activation [00EH.0]	[01H]Enable
Menu: page increment [028H.4-7]	[01H]WB
Menu: down [029H.0-3]	[07H]F
Menu: up [029H.4-7]	[03H]B
Menu: right [02AH.0-3]	[06H]E
Menu: left [02AH.4-7]	[04H]C
Menu: turn off [02BH.0-3]	[02H]A
Menu: enter [02BH.4-7]	[05H]D

1) Push button activation

Selects enable or disable for push button on camera and external switch functionality.

When selecting “Enable”, push button on camera and external switch functionality are activate and assigned function can be using.

When selecting “Disable”, push button on camera and external switch functionality are deactivate

2) Menu page increment

Selects the button for page increment function on OSD.

3) Menu down

Selects the button for cursor moves to down (selects next lower selection) function on OSD.

4) Menu up

Selects the button for cursor moves to up (selects next upper selection) function on OSD.

5) Menu right

Selects the button for cursor moves to right (selects next right selection) function on OSD.

6) Menu left

Selects the button for cursor moves to left (selects next left selection) function on OSD.

7) Menu turn off

Selects the button for return function on OSD.

8) Menu enter

Selects the button for executes selected function on OSD.

9) External switch

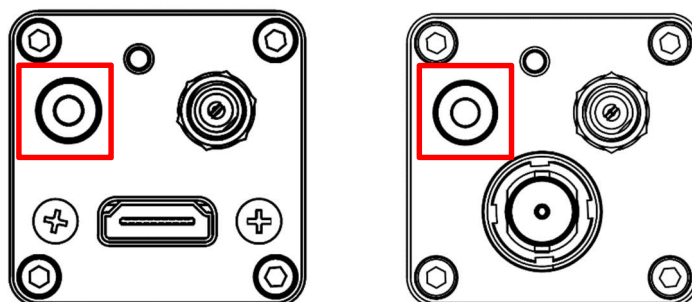

Switch Circuit Diagram,

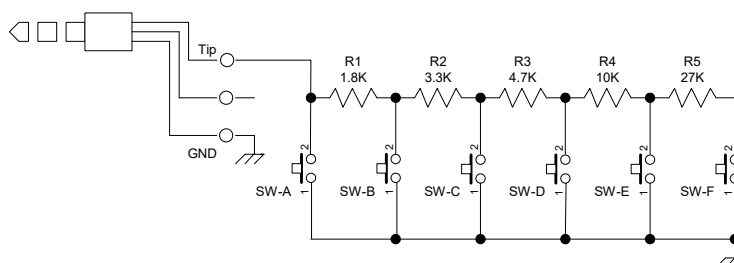



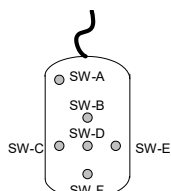

Example

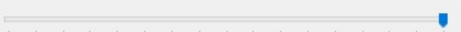

Line Maker (position/thickness)

Line Maker (position/thickness)

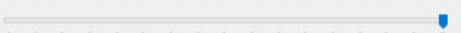
Horizontal line Min. position(for push button) [03AH.0-03BH.2]		0
Horizontal line Max. position(for push button) [03CH.0-03DH.2]		1920
Horizontal line Max. thickness(for push button) [03EH.0-03FH.2]		1920
Vertical line Min. position(for push button) [040H.0-041H.2]		0
Vertical line Max. position(for push button) [042H.0-043H.2]		1080
Vertical line Max. thickness(for push button) [044H.0-045H.2]		1080

1) Horizontal line Min. and Max. position (for push button)

Sets the minimum and maximum position of horizontal line that can be controlling with push button function.

2) Horizontal line Max. thickness (for push button)

Sets the maximum thickness of horizontal line that can be controlling with push button function.

3) Vertical line Min. and Max. position (for push button)

Sets the minimum and maximum position of vertical line that can be controlling with push button function.

4) Vertical line Max. thickness (for push button)

Sets the maximum thickness of vertical line that can be controlling with push button function.

Direct Key Function

Direct Key Function	
Primary switch function: single push [02CH]	[02H]PushLock WB[Save]
Primary switch function: hold [033H]	[03H]WBMode(AWB) [Save]
External switch A function: single push [02DH]	[01H]Display Menu
External switch A function: hold [034H]	[00H]Disabled
External switch B function: single push [02EH]	[00H]Disabled
External switch B function: hold [035H]	[00H]Disabled
External switch C function: single push [02FH]	[00H]Disabled
External switch C function: hold [036H]	[00H]Disabled
External switch D function: single push [030H]	[00H]Disabled
External switch D function: hold [037H]	[00H]Disabled
External switch E function: single push [031H]	[00H]Disabled
External switch E function: hold [038H]	[00H]Disabled
External switch F function: single push [032H]	[00H]Disabled
External switch F function: hold [039H]	[00H]Disabled

1) Switch function (single push / hold)

Selects the function for “single push” and “hold” action at individual button including push button on camera and buttons on external switch, from below selection.

Disabled	Display menu	Push Lock WB [Save]
WB Mode (Auto) [Save]	Change H inversion	Change V inversion
Change HV inversion	Change H inversion [Save]	Change V inversion [Save]
Change HV inversion [Save]	Change display marker	Change display line
Change display shadow	Change display circle	Change display marker [Save]
Change display line [Save]	Change display shadow [Save]	Change display circle [Save]
H line marker 1 position (+)	H line marker 1 position (-)	V line marker 1 position (+)
V line marker 1 position (-)	H line marker 2 position (+)	H line marker 2 position (-)
V line marker 2 position (+)	V line marker 2 position (-)	Shadow mask Top (+)
Shadow mask Top (-)	Shadow mask Bottom (+)	Shadow mask Bottom (-)
Shadow mask Left (+)	Shadow mask Left (-)	Shadow mask Right (+)
Shadow mask Right (-)	Circle marker H center position (+)	Circle marker H center position (-)
Circle marker V center position (+)	Circle marker V center position (-)	User Preset reset
Still image On/Off switch	User Preset (+)	User Preset 1
User Preset 0	User Preset 1	User Preset 2
User Preset 3	User Preset 4	User Preset 5
User Preset 6	User Preset 7	Digital Zoom (+)
Digital Zoom (-)	Digital Zoom pan (+)	Digital Zoom pan (-)
Digital Zoom tilt (+)	Digital Zoom tilt	Digital Zoom pan/tilt reset

* “Still image On/Off switch”, “Digital Zoom”, “Digital Zoom pan” and “Digital Zoom tilt” are available only STC-HD213DV, HD213DV-CS, HD213SDI and HD213SDI-CS.

uCOM: Other

The settings for User Preset, OSD, Digital Zoom, test pattern display, output range for DVI output and still image are changeable.

* Digital Zoom and still image functions are only available for STC-HD213DV, HD213DV-CS, HD213SDI and HD213SDI-CS

* Output range for DVI output is only available for DVI output models.

User Preset

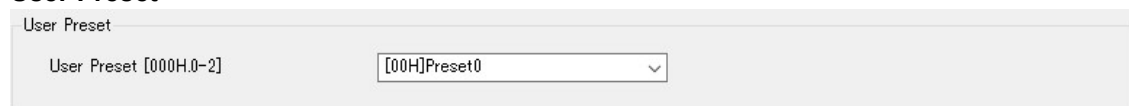

User Preset

User Preset [000H.0-2] [00H]Preset0

1) User Preset

Selects applying User Preset setting from “Preset0” to “Preset7”.

OSD



OSD

OSD menu color [050H.0-2] [07H]White

OSD character size [050H.3] [00H]Large

OSD horizontal position [051H] 0

OSD vertical position [052H] 0

OSD RGB level [053H] 186

OSD Edge level [054H] 16

1) OSD menu color

Selects color for displaying OSD menu.

2) OSD character size

Selects character size for displaying OSD menu

3) OSD horizontal position

Selects horizontal start position for displaying OSD menu.

4) OSD vertical position

Sets vertical start position for displaying OSD menu

5) OSD RGB level

Sets brightness level for displaying OSD menu.

6) OSD Edge level

Sets edge enhancement level for displaying OSD menu

Digital Zoom

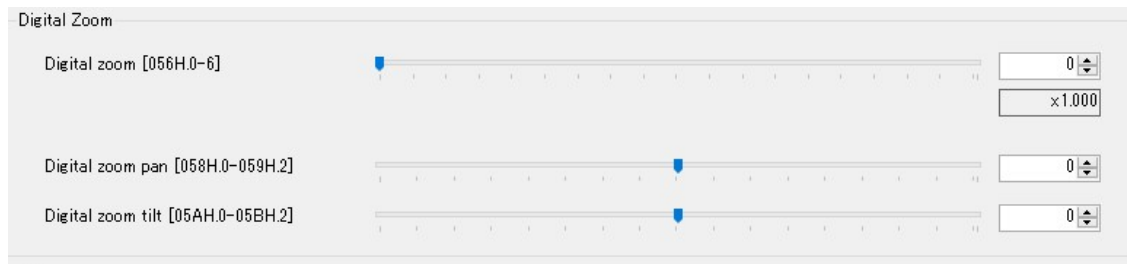

Digital Zoom

Digital zoom [056H.0-6]

Digital zoom pan [058H.0-059H.2]

Digital zoom tilt [05AH.0-05BH.2]

- 1) **Digital zoom**
Sets the magnification for digital zooming.
- 2) **Digital zoom pan**
Sets pan (horizontal offset) for digital zooming image.
- 3) **Digital zoom tilt**
Sets tilt (vertical offset) for digital zooming image.

Other



Other

Test pattern selection [055H.1-2]

Still image [055H.0]

DVI Output Range [05CH.0]

- 1) **Test pattern selection**
Selects the test pattern to check connecting monitor from "OFF (Video out)", "Gray scale", "Color bar" and "Color bar + Gray scale".
- 2) **Still image**
When selecting "ON", still image is output from camera.
When selecting "OFF", live video is output from camera.
- 3) **DVI Output Range**
Selects DVI output range for DVI output models from "Limited" and "Full".

uCOM: UART

The settings for UART communication are changeable.

UART

UART	
UART baud rate [00FH.0-2]	[02H]38400bps
UART short reply for write [00FH.6]	[00H]Disable
UART check sum [00FH.7]	[01H]Enable

1) UART baud rate

Selects baud rate for UART communication from “9600bps”, “19200bps”, “38400bps”, “57600bps” and “115200bps”.

2) UART short reply for write

When selecting “OFF”, receiving data from camera for writing command, does not include written data.
When selecting “ON”, receiving data from camera for writing command, includes written data.

3) UART check sum

Selects “Enable” or “Disable” for UART communication checksum.

uCOM: Blemish Pixel

The defective pixel detection and correction can be process.

The maximum 256 defective pixels can be correcting.

Pixel blemish correction

Pixel blemish correction

Pixel blemish correcting function [400H.4]

Locating pixel blemish correction area [401H.0]

Auto white blemish detection threshold [402H.0-403H.1]

Auto black blemish detection threshold [404H.0-405H.1]

00-07 08-15 16-23 24-31 32-39 40-47 48-55 56-63 64-71 72-79 80-87 88-95 96-103 104-111 112-119 120-127 128

Blemish pixel 000 horizontal position [600H.0-601H.3]

Blemish pixel 000 vertical position [602H.0-603H.3]

Blemish pixel 001 horizontal position [604H.0-605H.3]

Blemish pixel 001 vertical position [606H.0-607H.3]

Blemish pixel 002 horizontal position [608H.0-609H.3]

Blemish pixel 002 vertical position [60AH.0-60BH.3]

Blemish pixel 003 horizontal position [60CH.0-60DH.3]

Blemish pixel 003 vertical position [60EH.0-60FH.3]

Blemish pixel 004 horizontal position [610H.0-611H.3]

Blemish pixel 004 vertical position [612H.0-613H.3]

Blemish pixel 005 horizontal position [614H.0-615H.3]

Blemish pixel 005 vertical position [616H.0-617H.3]

Blemish pixel 006 horizontal position [618H.0-619H.3]

Blemish pixel 006 vertical position [61AH.0-61BH.3]

Blemish pixel 007 horizontal position [61CH.0-61DH.3]

Blemish pixel 007 vertical position [61EH.0-61FH.3]

1) Pixel blemish correcting function

When selecting "OFF", original video without defective pixel correction is output from camera.

When selecting "ON", defective pixel corrected video is output from camera.

2) Locating pixel blemish correction area

When selecting "ON", defective pixels are displaying highlighted on video.

3) Auto Detect

When selecting "Auto Detect" button, defective pixel detection process is starting.

* It is necessary to shading camera before starts defective pixel detection.

-
- 4) **Auto white blemish detection threshold**
Sets brightness threshold to detect defective pixel (white pixel / hot pixel) at detection process.
 - 5) **Auto black blemish detection threshold**
Sets brightness threshold to detect defective pixel (dark pixel) at detection process.
 - 6) **Blemish pixel 000 to 255 horizontal and vertical position**
Sets X and Y coordinates of defective pixel.
Displays X and Y coordinates of defective pixel that detected by auto detect function.
 - 7) **Sort Blemish Pixel**
Sorts X and Y coordinates of defective pixel as order of raster scanning (from upper left to lower bottom on image) automatically.

uCOM: ReadOnly

The version of firmware and FPGA of camera are displaying.

Version Information

Version Information		
Firmware version [300H.0-301H.7]	10	000A
FPGA version [302H.0-303H.7]	272	0110

OSD Cmd

The OSD functionality can be check.

Display Control Command	[01H]Display ON	[00H]Blinking OFF	
	[01H]Framing ON	[00H]Frame color - Black	
Video RAM Batch Clear Command			
Character Display Position Control Command	[00H]0Line	[00H]0dot	
Character Size Control Command	[00H]Row 0	[00H]H (x:1)	[00H]V (x:1)
Write Address Control Command	[00H]Row 0	[00H]Column 0	
Display Character Control Command	[00H]Character color reverse specification OFF	[07H]White	
	[00H]Character does not blink	[00H]Blank	
Send OSD Command (Max:32Bytes)	DC,33,25,2E,34,25,23,28,00,28,24,00,23,41,4D,45,52,41,00,FF,C8,33,34,23,0D,28,24,12,11,18,00,FF		

Field Table

The settings of camera including on EEPROM can be check on this table.

When selecting “Register” on each setting by left-click, each setting can be change on this table.

Device	Tab Page	Address	Field Name	EEPROM	Register
DSP	ShutterGain	000H.0	ALC mode	[01H]Enable(AEE/AGC c...	[01H]Enable(AEE/AGC c...
DSP	ShutterGain	000H.6	Exposure time control	[01H]Auto(AEE)	[01H]Auto(AEE)
DSP	ShutterGain	000H.7	Gain control	[01H]Auto(AGC)	[01H]Auto(AGC)
DSP	ShutterGain	001H	ALC target level	110	110
DSP	ShutterGain	002H.0-3	ALC integration-frame number	[01H]2	[01H]2
DSP	ShutterGain	003H.0-3	ALC rapid control frame number	[00H]0	[00H]0
DSP	ShutterGain	004H.0-005H.7	Exposure time	0	0
DSP	ShutterGain	006H.0-007H.7	AEE minimum exposure time	561	561
DSP	ShutterGain	008H.0-009H.7	AEE middle exposure time	0	0
DSP	ShutterGain	00AH.0-00BH.7	AEE maximum exposure time	0	0
DSP	ShutterGain	00CH	AEE tolerance	3	3
DSP	ShutterGain	00DH	AEE threshold	6	6
DSP	ShutterGain	00EH.0-6	AEE speed	0	0
DSP	ShutterGain	010H	Gain value	0	100
DSP	ShutterGain	011H	AGC minimum gain	0	0
DSP	ShutterGain	012H	AGC middle gain	30	30
DSP	ShutterGain	013H	AGC maximum gain	100	100
DSP	ShutterGain	014H	AGC tolerance	3	3
DSP	ShutterGain	015H	AGC threshold	6	6
DSP	ShutterGain	016H.0-4	AGC speed	0	0
DSP	ShutterGain	080H.0	Photometry mode	[00H]Average photometry	[00H]Average photometry
DSP	ShutterGain	081H.0-3	0frame coefficient	1	1
DSP	ShutterGain	082H.0-3	1frame coefficient	5	5
DSP	ShutterGain	083H.0-3	2frame coefficient	1	1
DSP	ShutterGain	084H.0-3	3frame coefficient	6	6
DSP	ShutterGain	085H.0-3	4frame coefficient	10	10
DSP	ShutterGain	086H.0-3	5frame coefficient	6	6
DSP	ShutterGain	087H.0-3	6frame coefficient	2	2
DSP	ShutterGain	088H.0-3	7frame coefficient	7	7
DSP	ShutterGain	089H.0-3	8frame coefficient	2	2
DSP	WhiteBalance	020H.0	White balance mode	[01H]Auto(AWB)	[01H]Auto(AWB)
DSP	WhiteBalance	020H.1	Pull-in limit in auto white balance mode	[01H]Enable	[01H]Enable
DSP	WhiteBalance	022H.0-023H.1	White balance R gain	421	481
DSP	WhiteBalance	024H.0-025H.1	White balance G gain	0	0
DSP	WhiteBalance	026H.0-027H.1	White balance B gain	247	169
DSP	WhiteBalance	02CH	AWB tolerance	3	3

Define the eight color table. The defined color can be used as Pseudo color and Line marker..

8 The Communication Protocol Specifications

8.1 The communication settings

Setting	Value
Baud rate	9,600 bps / 19,200 bps / 38,400 bps (Default) / 57,600 bps / 115,200 bps
Data bit	8 bits
Parity	None
Stop bit	1 bit
Flow control	None

8.2 The communication format

The format for sending / receiving data between PC and camera is in below:

STX	Command	Direction	Data length	Data	Check sum	ETX
8bits	8bits	1bit	15bits	[Data length] byte (Variable)	8bits	8bits

The details for format

	Details
STX	Start of Frame. This value is always "0x02".
Command	Command Code refer to "The Camera Control Command"
Direction	"0": Reading or receiving data from the camera is always a "0" value. "1": Writing or sending data to the camera is always a "1" value. Note: This value is always "0" when camera responding.
Data length	This "Data Length" value tells how many bytes "Data" will contain. The "Data Length" must be specified in bytes.
Data	This field is for set option, value and/or acquired value. The size must be specified as "Data Length".
Check sum	The "Check sum" functions to verify integrity of communication transmission. The "Check sum" value should equal last (low) 8 bits of summary of ["Command" + "Direction" + "Data Length" + "Data"].
ETX	End of Frame. This value is always "0x03".

8.3 Camera control commands

All data in this section is described in Hexadecimal format (HEX).

8.3.1 The command list for communication

Command (HEX)	Details
4A	<p>The format for reading data to camera IC's is as follows:</p> <p>In the case of writing, since maximum number of addresses can be written at once is 32 addresses, data must be written 8 times separately if 256 bytes data must be written.</p> <p>[SLV]: Slave Address (Please refer to the Slave address for ICs (8 bits) list)</p> <p>[START_H] x 16 + [START_L]: Star Address (0000 to 03FF)</p> <p>[END_H] x 16 + [END_L]: End Address (0000 to 03FF)</p> <p>[Data (i)]: Data on Address i</p> <p>[DataLenH]: Upper Byte of [END_H] x 16 + [END_L] - [START_H] x 16 + [START_L] + 6</p> <p>[DataLenL]: Lower Byte of [END_H] x 16 + [END_L] - [START_H] x 16 + [START_L] + 6</p> <p>The format for reading data to camera IC's is as follows:</p> <p>Send data 02, 4A, 00, 05, [SLV], [START_H], [START_L], [END_H], [END_L], [CHK], 03</p> <p>[CHK] = Lower 8bits of "4A + 00 + 05 + [SLV] + [START_H] + [START_L] + [END_H] + [END_L]"</p> <p>Receive Data 02, 4A, [DataLenH], [DataLenL], [SLV], [START_H], [START_L], [END_H], [END_L], [DATASTART], [DATASTART + 1], ... , [DATAEND], [CHK], 03</p> <p>[CHK] = Lower 8bits of "4A + [DataLenH] + [DataLenL] + [SLV] + [START_H] + [START_L] + [END_H] + [END_L] + [DATASTART] + [DATASTART + 1] + ... + [DATAEND]"</p> <p>*An example of sending a command to read out all data (address 0000 to 07FF) from IC (IC slave address is 50) is as follows: (02, 4A, 00, 03, 50, 00, 00, 07, FF, A3, 03)</p>

Command (HEX)	Details
4A	<p>The format for writing data to camera IC's is as follows:</p> <p>Send Data 02, 4A, [DataLenH] + 80, [DataLenL], [SLV], [START_H], [START_L], [END_H], [END_L], [DATASTART], [DATASTART + 1], ... , [DATAEND], [CHK], 03</p> <p>[CHK] = Lower 8bits of "4A + ([DataLenH] +80) + [DataLenL] + [SLV] + [START_H] + [START_L] + [END_H] + [END_L] + [DATASTART] + [DATASTART + 1] + ... + [DATAEND]"</p> <p>Receive Data 02, 4A, [DataLenH], [DataLenL], [SLV], [START_H], [START_L], [END_H], [END_L], [DATASTART], [DATASTART + 1], ... , [DATAEND], [CHK], 03</p> <p>[CHK] = Lower 8bits of "4A + [DataLenH] + [DataLenL] + [SLV] + [START_H] + [START_L] + [END_H] + [END_L] + [DATASTART] + [DATASTART + 1] + ... + [DATAEND]"</p> <p>*An example of the sending data to write 23 to address 10 of IC (IC slave address is 20) is as follows: (02, 4A, 80, 06, 20, 00, 10, 00, 10, 23, 33, 03)</p>
50	<p>This command is for sending an OSCD (On Screen Character Display) command to camera.</p> <p>As stated above, when writing OSCD commands to camera, 32 bytes is maximum amount of data that can be written to camera, with one communication.</p> <p>For additional information, please check section "OSCD Command".</p> <p>In order to generate an OSCD, set "Command" to a value of 50. Set OSCD command to Data, set number of byte of OSCD command to Data Length.</p> <p>* The format for sending a command to camera to clear display and then to generate a display of [0123] on 3rd row of 1st column is as follows: (02, 50, 80, 0A, 08, 92, 18, 38, DC, 10, 11, 12, 13, FF, E5, 03)</p>

8.3.2 Slave address for ICs (8bits) list

IC	Slave Address	詳細
DSP	82	DSP data
EEPROM	62	The Virtual EEPROM zone for currently selected DSP preset mode of Preset 0 to Preset 7
EEPROM	90	The EEPROM zone for Preset 0 DSP data
EEPROM	91	The EEPROM zone for Preset 1 DSP data
EEPROM	92	The EEPROM zone for Preset 2 DSP data
EEPROM	93	The EEPROM zone for Preset 3 DSP data
EEPROM	94	The EEPROM zone for Preset 4 DSP data
EEPROM	95	The EEPROM zone for Preset 5 DSP data
EEPROM	96	The EEPROM zone for Preset 6 DSP data
EEPROM	97	The EEPROM zone for Preset 7 DSP data
uCOM	22	The uCOM data
EEPROM	42	The EEPROM zone for uCOM Data

Note: There is maximum number of writing to EEPROM of 1,000,000 times.

8.3.3 Error code list

If an error occurs, camera sends an error code with following format:

The Command number of Error Message is FF (HEX). The Data length is 0002.

Error	Receive data
Last data that camera was received was not ETX (0x03)	02, FF, 00, 02, 02, 00, 03, 03
Check sum does NOT match data being transmitted	02, FF, 00, 02, 03, 00, 04, 03
The command being transmitted does NOT exist or is invalid	02, FF, 00, 02, 04, 00, 05, 03
Unprocessed data remains in receiving buffer	02, FF, 00, 02, 05, 00, 06, 03
Time out	02, FF, 00, 02, 06, 00, 07, 03
Over run error	02, FF, 00, 02, 08, 00, 08, 03
Data length error (too long)	02, FF, 00, 02, 0B, 00, 0C, 03
I2C communication error	02, FF, 00, 02, 10, 00, 11, 03

Note.1: The camera disregards data, which is not start with STX (0x02).

Note.2: The time out error is occurred when camera does not receive next data 3 seconds after receiving data.

8.4 The uCOM register mapping list

* Please do not change "Reserved data".

Address	7	6	5	4	3	2	1	0	Descriptions	Default
000						X	X	X	User Preset DSP register setting can save on eight Preset areas. * When this vale saves to EEPRM, camera starts with saved DSP mode at power up. 0: Preset 0 2: Preset 2 4: Preset 4 6: Preset 6 1: Preset 1 3: Preset 3 5: Preset 5 7: Preset 7	0
	X	X	X	X	X				Reserved	-
001 - 00D	X	X	X	X	X	X	X	X	Reserved	-
00E								X	"Push button" function 0: Disable 1: Enable	1
	X	X	X	X	X	X	X		Reserved	-
00F						X	X	X	UART baud rate 0: 9,600 bps 2: 38,400 bps 4: 115,200 bps 1: 19,200 bps 3: 57,000 bps * Change to lower baud rate when communication error is occurred.	2
			X	X	X				Reserved	-
		X							Return data and data length of UART write command 0: Disable. Return data is including exact same data of write command. 1: Enable. Return data is excluding data of write command, and data length is 0.	0
	X								UART check sum 0: Disable 1: Enable * When selecting disable, camera process command even check sum of send command is not mach.	1

Address	7	6	5	4	3	2	1	0	Descriptions	Default
010	X	X	X	X	X	X	X	X	User defined color 0 Red	255
011	X	X	X	X	X	X	X	X	User defined color 0 Green	128
012	X	X	X	X	X	X	X	X	User defined color 0 Blue	0
013	X	X	X	X	X	X	X	X	User defined color 1 Red	255
014	X	X	X	X	X	X	X	X	User defined color 1 Green	0
015	X	X	X	X	X	X	X	X	User defined color 1 Blue	128
016	X	X	X	X	X	X	X	X	User defined color 2 Red	128
017	X	X	X	X	X	X	X	X	User defined color 2 Green	255
018	X	X	X	X	X	X	X	X	User defined color 2 Blue	0
019	X	X	X	X	X	X	X	X	User defined color 3 Red	0
01A	X	X	X	X	X	X	X	X	User defined color 3 Green	255
01B	X	X	X	X	X	X	X	X	User defined color 3 Blue	128
01C	X	X	X	X	X	X	X	X	User defined color 4 Red	128
01D	X	X	X	X	X	X	X	X	User defined color 4 Green	0
01E	X	X	X	X	X	X	X	X	User defined color 4 Blue	255
01F	X	X	X	X	X	X	X	X	User defined color 5 Red	0
020	X	X	X	X	X	X	X	X	User defined color 5 Green	128
021	X	X	X	X	X	X	X	X	User defined color 5 Blue	255
022	X	X	X	X	X	X	X	X	User defined color 6 Red	128
023	X	X	X	X	X	X	X	X	User defined color 6 Green	128
024	X	X	X	X	X	X	X	X	User defined color 6 Blue	128
025	X	X	X	X	X	X	X	X	User defined color 7 Red	255
026	X	X	X	X	X	X	X	X	User defined color 7 Green	207
027	X	X	X	X	X	X	X	X	User defined color 7 Blue	0
028					X	X	X	X	Control button (decrement page) for display menu 0: Disable 1: Rear switch (WB) 2: Switch A 3: Switch B 4: Switch C 5: Switch D 6: Switch E 7: Switch F	0
	X	X	X	X					Control button (increment page) for display menu 0: Disable 1: Rear switch (WB) 2: Switch A 3: Switch B 4: Switch C 5: Switch D 6: Switch E 7: Switch F	1
029					X	X	X	X	Menu: down Selectable Parameters are same as Address 028	7
	X	X	X	X					Menu: up Selectable Parameters are same as Address 028	3
02A					X	X	X	X	Menu: right Selectable Parameters are same as Address 028	6
	X	X	X	X					Menu: left Selectable Parameters are same as Address 028	4
02B					X	X	X	X	Menu: return Selectable Parameters are same as Address 028	2
	X	X	X	X					Menu: enter Selectable Parameters are same as Address 028	5

Address	7	6	5	4	3	2	1	0	Descriptions	Default
02C	X	X	X	X	X	X	X	X	Default function of primary switch WB: single push * As for the detail of selectable function, please refer to Push button function list	2
02D	X	X	X	X	X	X	X	X	Default function of external switch A: single push * As for the detail of selectable function, please refer to Push button function list	1
02E	X	X	X	X	X	X	X	X	Default function of external switch B: single push * As for the detail of selectable function, please refer to Push button function list	0
02F	X	X	X	X	X	X	X	X	Default function of external switch C: single push * As for the detail of selectable function, please refer to Push button function list	0
030	X	X	X	X	X	X	X	X	Default function of external switch D: single push * As for the detail of selectable function, please refer to Push button function list	0
031	X	X	X	X	X	X	X	X	Default function of external switch E: single push * As for the detail of selectable function, please refer to Push button function list	0
032	X	X	X	X	X	X	X	X	Default function of external switch F: single push * As for the detail of selectable function, please refer to Push button function list	0
033	X	X	X	X	X	X	X	X	Default function of external switch WB: hold * As for the detail of selectable function, please refer to Push button function list	1
034	X	X	X	X	X	X	X	X	Default function of external switch A: hold * As for the detail of selectable function, please refer to Push button function list	0
035	X	X	X	X	X	X	X	X	Default function of external switch B: hold * As for the detail of selectable function, please refer to Push button function list	0
036	X	X	X	X	X	X	X	X	Default function of external switch C: hold * As for the detail of selectable function, please refer to Push button function list	0
037	X	X	X	X	X	X	X	X	Default function of external switch D: hold * As for the detail of selectable function, please refer to Push button function list	0
038	X	X	X	X	X	X	X	X	Default function of external switch E: hold * As for the detail of selectable function, please refer to Push button function list	0
039	X	X	X	X	X	X	X	X	Default function of external switch F: hold * As for the detail of selectable function, please refer to Push button function list	0
03A	X	X	X	X	X	X	X	X	Horizontal line minimum position [little-endian] (to Push Button)	0
03B	0	0	0	0	0	X	X	X		
03C	X	X	X	X	X	X	X	X	Horizontal line maximum position [little-endian] (to Push Button)	1,920
03D	0	0	0	0	0	X	X	X		
03E	X	X	X	X	X	X	X	X	Horizontal line minimum size (thickness) [little-endian] (to Push Button)	1,920
03F	0	0	0	0	0	X	X	X		

Address	7	6	5	4	3	2	1	0	Descriptions	Default
040	X	X	X	X	X	X	X	X	Vertical line minimum position [little-endian] (to Push Button)	0
041	0	0	0	0	0	X	X	X		
042	X	X	X	X	X	X	X	X	Vertical line maximum position [little-endian] (to Push Button)	1,080
043	0	0	0	0	0	X	X	X		
044	X	X	X	X	X	X	X	X	Vertical line minimum size (thickness) [little-endian] (to Push Button)	1,080
045	0	0	0	0	0	X	X	X		
046	X	X	X	X	X	X	X	X	Shadow Horizontal minimum position [little-endian] (for Push Button)	0
047	0	0	0	0	0	X	X	X		
048	X	X	X	X	X	X	X	X	Shadow Horizontal maximum position [little-endian] (for Push Button)	1,920
049	0	0	0	0	0	X	X	X		
04A	X	X	X	X	X	X	X	X	Shadow Vertical minimum position [little-endian] (for Push Button)	0
04B	0	0	0	0	0	X	X	X		
04C	X	X	X	X	X	X	X	X	Shadow Vertical maximum position [little-endian] (for Push Button)	1,080
04D	0	0	0	0	0	X	X	X		
04E - 04F	X	X	X	X	X	X	X	X	Reserved	-
050						X	X	X	OSD menu color 0: Black 1: Blue 2: Green 3: Cyan 4: Red 5: Magenta 6: Yellow 7: White	7
					X				OSD character size 0: Large 1: Small	0
	X	X	X	X						Reserved
051	X	X	X	X	X	X	X	X	OSD horizontal displaying position 0: Left to 256: Right	0
052	X	X	X	X	X	X	X	X	OSD vertical displaying position 0: Top to 256: Bottom	0
053	X	X	X	X	X	X	X	X	OSD RGB level	186
054	X	X	X	X	X	X	X	X	OSD edge level	16
055								X	Still Image 0: Off (Live video) 1: On (Still image) * This setting is valid only STC-HD213DV, HD213DV-CS, HD213SDI and HD213SDI-CS.	0
						X	X		Test Pattern selection 0: Off (Camera image) 1: Gray Scale 2: Color Bar 3: Color Bar + Gray Scale	0
	X	X	X	X	X					Reserved
056		X	X	X	X	X	X	X	Digital Zoom M = 128 / (128 - x) M: Magnification, x: Setting * This setting is valid only STC-HD213DV, HD213DV-CS, HD213SDI and HD213SDI-CS.	0
	X								Reserved	-
057	X	X	X	X	X	X	X	X	Reserved	-

Address	7	6	5	4	3	2	1	0	Descriptions	Default
402	X	X	X	X	X	X	X	X	Threshold of detecting hot defective pixel (White pixel) When detecting defective pixel, pixel has greater pixel value than this setting, is detecting as hot defective pixel.	70
403	X	X	X	X	X	X	X	X		
404	X	X	X	X	X	X	X	X	Threshold of detecting dead defective pixel (Black pixel) When detecting defective pixel, pixel has smaller pixel value than this setting, is detecting as hot defective pixel.	70
405	X	X	X	X	X	X	X	X		
406 - 5FF	X	X	X	X	X	X	X	X	Reserved	-
600	X	X	X	X	X	X	X	X	Defective pixel horizontal position 000	-
601	0	0	0	0	X	X	X	X		
602	X	X	X	X	X	X	X	X	Defective pixel vertical position 000	-
603	0	0	0	0	X	X	X	X		
604	X	X	X	X	X	X	X	X	Defective pixel horizontal position 001	-
605	0	0	0	0	X	X	X	X		
606	X	X	X	X	X	X	X	X	Defective pixel vertical position 001	-
607	0	0	0	0	X	X	X	X		
608	X	X	X	X	X	X	X	X	Defective pixel horizontal position 002	-
609	0	0	0	0	X	X	X	X		
60A	X	X	X	X	X	X	X	X	Defective pixel vertical position 002	-
60B	0	0	0	0	X	X	X	X		
60C	X	X	X	X	X	X	X	X	Defective pixel horizontal position 003	-
60D	0	0	0	0	X	X	X	X		
60E	X	X	X	X	X	X	X	X	Defective pixel vertical position 003	-
60F	0	0	0	0	X	X	X	X		
610	X	X	X	X	X	X	X	X	Defective pixel horizontal position 004	-
611	0	0	0	0	X	X	X	X		
612	X	X	X	X	X	X	X	X	Defective pixel vertical position 004	-
613	0	0	0	0	X	X	X	X		
614	X	X	X	X	X	X	X	X	Defective pixel horizontal position 005	-
615	0	0	0	0	X	X	X	X		
616	X	X	X	X	X	X	X	X	Defective pixel vertical position 005	-
617	0	0	0	0	X	X	X	X		
618	X	X	X	X	X	X	X	X	Defective pixel horizontal position 006	-
618	0	0	0	0	X	X	X	X		
61A	X	X	X	X	X	X	X	X	Defective pixel vertical position 006	-
61B	0	0	0	0	X	X	X	X		
61C	X	X	X	X	X	X	X	X	Defective pixel horizontal position 007	-
61D	0	0	0	0	X	X	X	X		
61E	X	X	X	X	X	X	X	X	Defective pixel vertical position 007	-
61F	0	0	0	0	X	X	X	X		
620 - 64F	X	X	X	X	X	X	X	X	Defective pixel position 008 to 019	-
650 - 67F	X	X	X	X	X	X	X	X	Defective pixel position 020 to 031	-
680 - 6BF	X	X	X	X	X	X	X	X	Defective pixel position 032 to 047	-

Address	7	6	5	4	3	2	1	0	Descriptions	Default
6C0 - 6FF	X	X	X	X	X	X	X	X	Defective pixel position 048 to 063	-
700 - 73F	X	X	X	X	X	X	X	X	Defective pixel position 064 to 079	-
740 - 77F	X	X	X	X	X	X	X	X	Defective pixel position 080 to 095	-
780 - 7BF	X	X	X	X	X	X	X	X	Defective pixel position 096 to 111	-
7C0 - 7FF	X	X	X	X	X	X	X	X	Defective pixel position 112 to 0127	-
800 - 83F	X	X	X	X	X	X	X	X	Defective pixel position 128 to 143	-
840 - 87F	X	X	X	X	X	X	X	X	Defective pixel position 144 to 159	-
880 - 8BF	X	X	X	X	X	X	X	X	Defective pixel position 160 to 175	-
8C0 - 8FF	X	X	X	X	X	X	X	X	Defective pixel position 176 to 191	-
900 - 93F	X	X	X	X	X	X	X	X	Defective pixel position 192 to 207	-
940 - 97F	X	X	X	X	X	X	X	X	Defective pixel position 208 to 223	-
980 - 9BF	X	X	X	X	X	X	X	X	Defective pixel position 224 to 239	-
9C0 - 9FF	X	X	X	X	X	X	X	X	Defective pixel position 240 to 255	-

8.4.1 Push Button Function on Meru

When menu is displayed, the following function is assign for each Push Button.

WB: Increment Page	increment page number
SW A: Return	Close the menu
SW B: Increment	Cursor moves to up / increment value
SW C: Select Left	Select left selection
SW D: Execute	Execute the selected function
SW E: Select Right	Select right selection
SW F: Decrement	Cursor moves to down / decrement value

8.4.2 Push button function list

Value	Function	Function Descriptions
0x00	Disabled	Disables push button control
0x01	Display Menu	Displaying the menu on screen
0x02	Push Lock WB [Save to EEPROM]	Execute Push to set white balance process then save mode and gain settings to EEPROM
0x03	WB mode (AWB) [Save to EEPROM]	Sets "Auto" white balance mode, and save mode setting to EEPROM
0x04	Change H Inversion	Switches horizontal flipped image and normal image
0x05	Change V Inversion	Switches vertical flipped image and normal image
0x06	Change HV Inversion	Switches horizontal and vertical flipped image and normal image
0x07	Change H Inversion [Save]	Switches horizontal flipped image and normal image, then save to EEPROM
0x08	Change V Inversion [Save]	Switches vertical flipped image and normal image, then save to EEPROM
0x09	Change HV Inversion [Save]	Switches horizontal and vertical flipped image and normal image then save to EEPROM
0x0A	Change display marker	Switches enable and disable marker display
0x0B	Change display line	Switches enable and disable line marker display
0x0C	Change display shadow	Switches enable and disable shadow mask display
0x0D	Change display circle marker	Switches enable and disable circle maker display
0x0E	Change display marker [Save]	Switches enable and disable marker display, then save to EEPROM
0x0F	Change display line [Save]	Switches enable and disable line marker display, then save to EEPROM
0x10	Change display shadow [Save]	Switches enable and disable shadow mask display, then save to EEPROM
0x11	Change display circle marker [Save]	Switches enable and disable circle maker display, then save to EEPROM
0x12	H Line Maker1 position (+)	Moves horizontal line marker1 to bottom.
0x13	H Line Maker1 position (-)	Moves horizontal line marker1 to top.
0x14	V Line Maker1 position (+)	Moves vertical line marker1 to left.
0x15	V Line Maker1 position (-)	Moves vertical line marker1 to right.
0x16	H Line Maker2 position (+)	Moves horizontal line marker to bottom
0x17	H Line Maker2 position (-)	Moves horizontal line marker2 to top.
0x18	V Line Maker2 position (+)	Moves vertical line marker2 to left.
0x19	V Line Maker2 position (-)	Moves vertical line marker2 to right.
0x1A	Shadow mask Top (+)	Expands height of shadow mask top to bottom.
0x1B	Shadow mask Top (-)	Contracts height of shadow mask top to top.
0x1C	Shadow mask Bottom (+)	Contracts height of shadow mask bottom to bottom.
0x1D	Shadow mask Bottom (-)	Expands height of shadow mask bottom to top.
0x1E	Shadow mask Left (+)	Expands height of shadow mask left to right.
0x1F	Shadow mask Left (-)	Contracts height of shadow mask left to left.
0x20	Shadow mask Right (+)	Contracts height of shadow mask right to right.
0x21	Shadow mask Right (-)	Expands height of shadow mask right to left.
0x22	Circle maker H position (+)	Moves center of circle marker to right.
0x23	Circle maker H position (-)	Moves center of circle marker to left.
0x24	Circle maker V position (+)	Moves center of circle marker to bottom.
0x25	Circle maker V position (-)	Moves center of circle marker to top
0x26	Change still image	Switches still image display and live image display * This is available for STC-HD213DV, HD213DV-CS, H213SDI and HD213SDI-CS
0x27	User preset (+)	Switches user preset (0 to 1 to XX to 7 to 0 to ...)
0x28	Reset user preset	Resets user preset to put it back that saved EEPOM

Value	Function	Function Descriptions
0x29	User Preset 0	Loads settings of user preset 0
0x2A	User Preset 1	Loads settings of user preset 1
0x2B	User Preset 2	Loads settings of user preset 2
0x2C	User Preset 3	Loads settings of user preset 3
0x2D	User Preset 4	Loads settings of user preset 4
0x2E	User Preset 5	Loads settings of user preset 5
0x2F	User Preset 6	Loads settings of user preset 6
0x30	User Preset 7	Loads settings of user preset 7
0x31	Digital Zoom (+)	Digital zooming in * This is available for STC-HD213DV, HD213DV-CS, H213SDI and HD213SDI-CS
0x32	Digital Zoom (-)	Digital zooming out * This is available for STC-HD213DV, HD213DV-CS, H213SDI and HD213SDI-CS
0x33	Digital Zoom pan (+)	Moves displaying digital zooming image to right * This is available for STC-HD213DV, HD213DV-CS, H213SDI and HD213SDI-CS
0x34	Digital Zoom pan (-)	Moves displaying digital zooming image to left * This is available for STC-HD213DV, HD213DV-CS, H213SDI and HD213SDI-CS
0x35	Digital Zoom tilt (+)	Moves displaying digital zooming image to top * This is available for STC-HD213DV, HD213DV-CS, H213SDI and HD213SDI-CS
0x36	Digital Zoom tilt (-)	Moves displaying digital zooming image to bottom * This is available for STC-HD213DV, HD213DV-CS, H213SDI and HD213SDI-CS
0x37	Digital Zoom pan / tilt reset	Resets settings of pan and tilt to 0. * This is available for STC-HD213DV, HD213DV-CS, H213SDI and HD213SDI-CS

8.5 The DSP register mapping list

* Please do not change access "Reserved data".

Address	7	6	5	4	3	2	1	0	Descriptions	Default
000								X	ALC mode 0: Disable (fixed exposing / fixed gain) 1: Enable (exposing control / gain control)	1
			X	X	X	X	X		Reserved	-
		X							Exposing control (AEE) 0: Fixed exposing 1: Auto exposing (AEE)	1
	X								Gain control 0: Fixed gain 1: Auto gain (AGC)	1
001	X	X	X	X	X	X	X	X	ALC target brightness	110
002	0	0	0	0	X	X	X	X	Number of frames for ALC process The brightness control with average brightness of specified number of frames image. 0: 1 frame (no average) 1: 2 frames 2: 4 frames 3: 8 frames 4: 16 frames 5: 32 frames 6: 64 frames 7: 128 frames 8: 256 frames 9: 512 frames	1
003	0	0	0	0	X	X	X	X	Number of frames for ALC rapid process The number of frames for high speed ALC processing when power on camera or changes displaying mode. 0: 0 frame (no high speed process) 1: 1 frames 2: 2 frames 3: 4 frames 4: 8 frames 5: 16 frames 6: 32 frames 7: 64 frames 8: 128 frames 9: 256 frames 10: 512 frames	0
004	X	X	X	X	X	X	X	X	Exposure time [little-endian] * Two's compliment -447 to 561 * 0 to 561 for STC-HD213DVN, HD213DNNV-CS, HD213SDIN and HD213SDIN-CS	0
005	X	X	X	X	X	X	X	X		
006	X	X	X	X	X	X	X	X	AEE minimum exposure time [little-endian] * Two's compliment -447 to 561 * 0 to 561 for STC-HD213DVN, HD213DNNV-CS, HD213SDIN and HD213SDIN-CS	561
007	X	X	X	X	X	X	X	X		
008	X	X	X	X	X	X	X	X	AEE middle exposure time [little-endian] * Two's compliment -447 to 561 * 0 to 561 for STC-HD213DVN, HD213DNNV-CS, HD213SDIN and HD213SDIN-CS	0
009	X	X	X	X	X	X	X	X		

Address	7	6	5	4	3	2	1	0	Descriptions	Default
00A	X	X	X	X	X	X	X	X	AEE maximum exposure time [little-endian] * Two's compliment -447 to 561 * 0 to 561 for STC-HD213DVN, HD213DNNV-CS, HD213SDIN and HD213SDIN-CS	0
00B	X	X	X	X	X	X	X	X		
00C	X	X	X	X	X	X	X	X	Brightness tolerance for AEE control The auto exposing control is stopped when differences between "target brightness" and current brightness of image is smaller than this value.	3
00D	X	X	X	X	X	X	X	X	Brightness threshold for AEE control The auto exposing control is starting when differences between "target brightness" and current brightness of image is greater than "tolerance + threshold".	6
00E	0	X	X	X	X	X	X	X	AEE control speed The maximum change of exposure time for auto exposing control is limit by this value. * There is not limit when setting 0	0
00F	X	X	X	X	X	X	X	X	Reserved	-

The relationship between setting and exposure time

The relationship between setting and exposure time is changing based by selected "Resolution / frame rate"
setting
[0x060]

* The range of setting for STC-HD213DVN, HD213DNNV-CS, HD213SDIN and HD213SDIN-CS is "0 to 561".

60 fps frame rate

Setting	Exposure time		Setting	Exposure time	
0	16.64 [msec.]	1/60.1 [sec.]	-64	33.3 [msec.]	1/30 [sec.]
225	9.99 [msec.]	1/100.1 [sec.]	-128	66.7 [msec.]	2/30 [sec.]
281	8.33 [msec.]	1/120.1 [sec.]	-192	133.3 [msec.]	4/30 [sec.]
393	5.01 [msec.]	1/199.7 [sec.]	-256	266.7 [msec.]	8/30 [sec.]
450	3.32 [msec.]	1/301.3 [sec.]	-320	533.3 [msec.]	16/30 [sec.]
495	1.99 [msec.]	1/503.7 [sec.]	-384	1.07 [sec.]	32/30 [sec.]
561	29.6 [usec.]	1/33,750 [sec.]	-447	2.12 [sec.]	64/30 [sec.]

50 fps frame rate

Setting	Exposure time		Setting	Exposure time	
0	19.96 [msec.]	1/50.1 [sec.]	-64	40.0 [msec.]	1/25 [sec.]
281	9.99 [msec.]	1/100.1 [sec.]	-128	80.0 [msec.]	2/25 [sec.]
328	8.32 [msec.]	1/120.2 [sec.]	-192	160.0 [msec.]	4/25 [sec.]
421	5.01 [msec.]	1/199.5 [sec.]	-256	320.0 [msec.]	8/25 [sec.]
450	3.98 [msec.]	1/251.1 [sec.]	-320	640.0 [msec.]	16/25 [sec.]
506	1.99 [msec.]	1/502.2 [sec.]	-384	1.28 [sec.]	32/25 [sec.]
561	35.6 [usec.]	1/28,125 [sec.]	-447	2.56 [sec.]	64/25 [sec.]

30 fps frame rate

Setting	Exposure time		Setting	Exposure time	
0	33.27 [msec.]	1/30.1 [sec.]	-64	66.7 [msec.]	1/15 [sec.]
225	19.97 [msec.]	1/50.1 [sec.]	-128	133.3 [msec.]	2/15 [sec.]
281	16.65 [msec.]	1/60.1 [sec.]	-192	266.7 [msec.]	4/15 [sec.]
421	8.36 [msec.]	1/119.7 [sec.]	-256	533.3 [msec.]	8/15 [sec.]
478	4.98 [msec.]	1/200.9 [sec.]	-320	1.07 [sec.]	16/15 [sec.]
506	3.32 [msec.]	1/301.3 [sec.]	-384	2.13 [sec.]	32/15 [sec.]
561	59.3 [usec.]	1/16,875 [sec.]	-447	4.23 [sec.]	64/15 [sec.]

25 fps frame rate

Setting	Exposure time		Setting	Exposure time	
0	39.93 [msec.]	1/25.0 [sec.]	-64	80.0 [msec.]	2/25 [sec.]
281	19.99 [msec.]	1/50.0 [sec.]	-128	160.0 [msec.]	4/25 [sec.]
328	16.64 [msec.]	1/60.1 [sec.]	-192	320.0 [msec.]	8/25 [sec.]
421	10.03 [msec.]	1/99.7 [sec.]	-256	640.0 [msec.]	16/25 [sec.]
492	4.98 [msec.]	1/200.9 [sec.]	-320	1.28 [sec.]	32/25 [sec.]
506	3.98 [msec.]	1/251.1 [sec.]	-384	2.56 [sec.]	64/25 [sec.]
561	71.1 [usec.]	1/14,063 [sec.]	-447	5.08 [sec.]	128/25 [sec.]

Address	7	6	5	4	3	2	1	0	Descriptions	Default
010	X	X	X	X	X	X	X	X	Gain Range: 0 to 150	0
011	X	X	X	X	X	X	X	X	Minimum gain for AGC Range: 0 to 150	0
012	X	X	X	X	X	X	X	X	Middle gain for AGC Range: 0 to 150	30
013	X	X	X	X	X	X	X	X	Maximum gain for AGC Range: 0 to 150	100
014	X	X	X	X	X	X	X	X	Brightness tolerance for AGC control The AGC control is stopped when differences between “target brightness” and current brightness of image is smaller than this value.	3
015	X	X	X	X	X	X	X	X	Brightness threshold for AGC control The AGC control is starting when differences between “target brightness” and current brightness of image is greater than “tolerance + threshold”.	6
016	0	X	X	X	X	X	X	X	AGC control speed The maximum change of gain for AGC control is limit by this value. * There is not limit when setting 0	0
017 - 01F	X	X	X	X	X	X	X	X	Reserved	-

The formula of gain:

$$G \text{ [dB]} = 0.3 \times \text{gain setting}$$

The interlock between auto exposing control (ALC) and auto gain control (AGC)

Object	Exposure time setting	Gain setting
Bright	AEE minimum exposure time	AGC minimum gain
	Fluctuating	
	AEE middle exposure time	Fluctuating
	Fluctuating	AGC middle gain
Dark	AEE maximum exposure time	Fluctuating
		AGC maximum gain

It is necessary to set minimum, middle and maximum AEE exposure time and AGC gain as below order.

AEE minimum exposure time <= AEE middle exposure time <= AEE maximum exposure time

AGC minimum gain <= AGC middle gain <= AGC maximum gain

Address	7	6	5	4	3	2	1	0	Descriptions	Default
020								X	White balance mode 0: Manual 1: Auto (AWB)	1
							X		Gain limit for AWB 0: Disable (no pull-in limit) 1: Enable (with pull-in limit)	1
			X	X	X	X			Reserved	-
		X							White balance gain data saves to EEPROM when finishing push to set white balance process 0: OFF (data does not save) 1: ON (data saves and automatically turn 0)	0
		X							Push to set white balance mode 0: OFF 1: ON (Automatically turn 0, after convergence)	0
021	X	X	X	X	X	X	X	X	Reserved	-
022	X	X	X	X	X	X	X	X	White balance R gain [little-endian]	421
023	0	0	0	0	0	0	X	X	R Gain = (this value + 256) / 256 [x times]	
024	X	X	X	X	X	X	X	X	White balance G gain [little-endian]	0
025	0	0	0	0	0	0	X	X	G Gain = (this value + 256) / 256 [x times]	
026	X	X	X	X	X	X	X	X	White balance B gain [little-endian]	247
027	0	0	0	0	0	0	X	X	B Gain = (this value + 256) / 256 [x times]	
028 - 02B	X	X	X	X	X	X	X	X	Reserved	-
02C	X	X	X	X	X	X	X	X	Tolerance for white balance control (no pull-in limit control) The auto white balance control (no pull-in limit control) is stopped when error of white balance is smaller than this value.	3
02D	X	X	X	X	X	X	X	X	Threshold for AGC control (no pull-in limit control) The auto white balance control (no pull-in limit control) is starting when error of white balance is greater than "tolerance + threshold".	3
02E - 02F	X	X	X	X	X	X	X	X	Reserved	-
030	0	0	0	0	X	X	X	X	AWB number of frames for average brightness The auto white balance control with average white balance data of specified number of frames image. 0: 1 frame (no average) 1: 2 frames 2: 4 frames 3: 8 frames 4: 16 frames 5: 32 frames 6: 64 frames 7: 128 frames 8: 256 frames 9: 512 frames	1
031	0	0	0	0	X	X	X	X	AWB number of frames for high speed process The number of frames for high speed AWB processing when power on camera or changes displaying mode. 0: 0 frame (no high speed process) 1: 1 frames 2: 2 frames 3: 4 frames 4: 8 frames 5: 16 frames 6: 32 frames 7: 64 frames 8: 128 frames 9: 256 frames 10: 512 frames	0

Address	7	6	5	4	3	2	1	0	Descriptions	Default
032	X	X	X	X	X	X	X	X	Auto white balance (no pull-in limit) process speed (AWB R)	4
033	X	X	X	X	X	X	X	X	Auto white balance (no pull-in limit) process speed (AWB B)	4
034	X	X	X	X	X	X	X	X	R gain for low color temperature reference point [little-endian]	229
035	X	X	X	X	X	X	X	X		
036	X	X	X	X	X	X	X	X	B gain for low color temperature reference point [little-endian]	474
037	X	X	X	X	X	X	X	X		
038	X	X	X	X	X	X	X	X	R gain for middle color temperature reference point [little-endian]	518
039	X	X	X	X	X	X	X	X		
03A	X	X	X	X	X	X	X	X	B gain for middle color temperature reference point [little-endian]	193
03B	X	X	X	X	X	X	X	X		
03C	X	X	X	X	X	X	X	X	R gain for high color temperature reference point [little-endian]	748
03D	X	X	X	X	X	X	X	X		
03E	X	X	X	X	X	X	X	X	B gain for high color temperature reference point [little-endian]	120
03F	X	X	X	X	X	X	X	X		
040	X	X	X	X	X	X	X	X	Tolerance for white balance control (with pull-in limit control) The auto white balance control (with pull-in limit control) is stopped when error of white balance is smaller than this value.	3
041	X	X	X	X	X	X	X	X	Threshold for AGC control (with pull-in limit control) The auto white balance control (with pull-in limit control) is starting when error of white balance is greater than "tolerance + threshold".	6
042	X	X	X	X	X	X	X	X	Auto white balance (no pull-in limit) divisor step for AWB	10
043	X	X	X	X	X	X	X	X	Reserved	-
044	X	X	X	X	X	X	X	X	R gain for low color temperature reference point for + frame	30
045	X	X	X	X	X	X	X	X	R gain for low color temperature reference point for - frame	30
046	X	X	X	X	X	X	X	X	B gain for low color temperature reference point for + frame	30
047	X	X	X	X	X	X	X	X	B gain for low color temperature reference point for - frame	30
048	X	X	X	X	X	X	X	X	R gain for middle color temperature reference point for + frame	30
049	X	X	X	X	X	X	X	X	R gain for middle color temperature reference point for - frame	30
04A	X	X	X	X	X	X	X	X	B gain for middle color temperature reference point for + frame	30
04B	X	X	X	X	X	X	X	X	B gain for middle color temperature reference point for - frame	30
04C	X	X	X	X	X	X	X	X	R gain for high color temperature reference point for + frame	30
04D	X	X	X	X	X	X	X	X	R gain for high color temperature reference point for - frame	30
04E	X	X	X	X	X	X	X	X	B gain for high color temperature reference point for + frame	30
04F	X	X	X	X	X	X	X	X	B gain for high color temperature reference point for - frame	30
050 - 05F	X	X	X	X	X	X	X	X	Reserved	-

Address	7	6	5	4	3	2	1	0	Descriptions	Default
060	0	0	0	0	X	X	X	X	Resolution/Frame Rate 0: 1080p 60fps 1: 1080p 30fps 2: 1080i 60fps 3: 1080p 50fps 4: 1080pP 25fps 5: 1080i 50fps 6: 720p 60fps 7: 720p 50 fps 8: 1080p 59.94fps 9: 1080p 29.97fps 10: 1080i 59.94fps 11: 720p 59.94fps 12: Auto * Auto is only available for DVI output models. (When selecting "Auto", resolution/frame rate is selecting automatically based on connected monitor supports)	0
061								X	Horizontal image flip 0: OFF (No flip) 1: ON (horizontal flipped image)	0
							X		Vertical image flip 0: OFF (No flip) 1: ON (vertical flipped image)	
	X	X	X	X	X	X			Reserved	-
062	X	X	X	X	X	X	X	X	Reserved	-
063					X	X	X	X	Preset gamma selection 0: 1.0 1: 0.9 2: 0.8 3: 0.7 4: 0.6 5: 0.5 6: 0.45 7: 0.3 9: Through * Selected preset gamma is valid when selecting "Preset gamma" at "Gamma mode"	0
		X	X	X					Reserved	-
	X								Gamma Mode 0: Preset gamma 1: Manual	1
	X	X	X						Reserved	-
064	X	X	X	X	X	X	X	X	Manual Gamma 0 [little-endian] * Two's compliment	0
065	0	0	0	0	0	0	X	X		
066	X	X	X	X	X	X	X	X	Manual Gamma 1 [little-endian] * Two's compliment	68
067	0	0	0	0	0	0	X	X		
068	X	X	X	X	X	X	X	X	Manual Gamma 2 [little-endian] * Two's compliment	130
069	0	0	0	0	0	0	X	X		
06A	X	X	X	X	X	X	X	X	Manual Gamma 3 [little-endian] * Two's compliment	159
06B	0	0	0	0	0	0	X	X		
06C	X	X	X	X	X	X	X	X	Manual Gamma 4 [little-endian] * Two's compliment	181
06D	0	0	0	0	0	0	X	X		
06E	X	X	X	X	X	X	X	X	Manual Gamma 5 [little-endian] * Two's compliment	200
06F	0	0	0	0	0	0	X	X		
070	X	X	X	X	X	X	X	X	Manual Gamma 6 [little-endian] * Two's compliment	220
071	0	0	0	0	0	0	X	X		

Address	7	6	5	4	3	2	1	0	Descriptions	Default
072	X	X	X	X	X	X	X	X	Manual Gamma 7 [little-endian] * Two's compliment	237
073	0	0	0	0	0	0	X	X		
074	X	X	X	X	X	X	X	X	Manual Gamma 8 [little-endian] * Two's compliment	251
075	0	0	0	0	0	0	X	X		
076	X	X	X	X	X	X	X	X	Manual Gamma 9 [little-endian] * Two's compliment	256
077	0	0	0	0	0	0	X	X		
078 - OFF	X	X	X	X	X	X	X	X	Reserved	-

Photometry Mode

In order to achieve the optimum luminance, photometry mode of this DSP either automatically adjusts gain value and exposure time to achieve optimum luminance level by detecting luminance signals in screen region using 9 frames (3 horizontal x 3 vertical frames) and giving weighting to this region on screen.

Average Photometry: This evaluation mode uses same weighting for all 9 frames

Weight Photometry: The weighting for each of 9 frames can be specified.

Address	7	6	5	4	3	2	1	0	Descriptions	Default
100								X	Line Marker 0: Disable 1: Enabler	1
							X		Shadow Mask 0: Disable 1: Enable	1
						X			Circle Mask 0: Disable 1: Enable	1
		X	X	X	X				Reserved	-
	X								Marker 0: Disable 1: Enable	1
101	X	X	X	X	X	X	X	X	Shadow mask shading level 0: Invisible to 255: Black	0
102	X	X	X	X	X	X	X	X	Horizontal shadow mask top position [little-endian] 0: Top to 1,080: Bottom	0
103	0	0	0	0	X	X	X	X		
104	X	X	X	X	X	X	X	X	Horizontal shadow mask bottom position [little-endian] 0: Top to 1,080: Bottom	1,080
105	0	0	0	0	X	X	X	X		
106	X	X	X	X	X	X	X	X	Vertical shadow mask left position [little-endian] 0: Left to 1,920: Right	0
107	0	0	0	0	X	X	X	X		
108	X	X	X	X	X	X	X	X	Vertical shadow mask right position [little-endian] 0: Left to 1,920: Right	1,920
109	0	0	0	0	X	X	X	X		
10A					X	X	X	X	Vertical line 1 marker color *as for the configurable color, please refer to color code chart	0
	X	X	X	X					Horizontal line 1 marker color *as for the configurable color, please refer to color code chart	0
10B	X	X	X	X	X	X	X	X	Reserved	-
10C	X	X	X	X	X	X	X	X	Horizontal line 1 marker position [little-endian] 0: Top to 1,080: Bottom	0
10D	0	0	0	0	0	0	0	X		
10E	X	X	X	X	X	X	X	X	Horizontal line 1 marker thickness (size) [little-endian] 0: Invisible to 1,080: Maximum	0
10F	0	0	0	0	0	0	0	X		
110	X	X	X	X	X	X	X	X	Vertical line 1 marker position [little-endian] 0: Left to 1,920: Right	0
111	0	0	0	0	0	0	0	X		
112	X	X	X	X	X	X	X	X	Vertical line 1 marker thickness (size) [little-endian] 0: Invisible to 1,920: Maximum	0
113	0	0	0	0	0	0	0	X		
114					X	X	X	X	Horizontal line 2 marker color *as for the configurable color, please refer to color code chart	0
	X	X	X	X					Vertical line 2 marker color *as for the configurable color, please refer to color code chart	9
115	X	X	X	X	X	X	X	X	Reserved	-
116	X	X	X	X	X	X	X	X	Horizontal line 2 marker position [little-endian] 0: Top to 1,080: Bottom	0
117	0	0	0	0	0	0	0	X		
118	X	X	X	X	X	X	X	X	Horizontal line 2 marker thickness (size) [little-endian] 0: Invisible to 1,080: Maximum	0
119	0	0	0	0	0	0	0	X		
11A	X	X	X	X	X	X	X	X	Vertical line 2 marker position [little-endian] 0: Left to 1,920: Right	0
11B	0	0	0	0	0	0	0	X		
11C	X	X	X	X	X	X	X	X	Vertical line 2 marker thickness (size) [little-endian] 0: Invisible to 1,920: Maximum	0
11D	0	0	0	0	0	0	0	X		

Address	7	6	5	4	3	2	1	0	Descriptions	Default
11E	0	0	0	0	X	X	X	X	Circle marker color *as for the configurable color, please refer to color code chart	0
	X	X	X	X					Reserved	-
11F	X	X	X	X	X	X	X	X	Reserved	-
120	X	X	X	X	X	X	X	X	Circle marker radius	0
121	0	0	0	0	X	X	X	X		
122	X	X	X	X	X	X	X	X	Circle marker thickness (size)	0
123	0	0	0	0	X	X	X	X		
124	X	X	X	X	X	X	X	X	Circle marker center position (horizontal) [little-endian] 0: Left to 1,920: Right	960
125	0	0	0	0	X	X	X	X		
126	X	X	X	X	X	X	X	X	Circle marker center position (vertical) [little-endian] 0: Top to 1,080: Bottom	540
127	0	0	0	0	X	X	X	X		
128								X	Picture mode selection 0: Normal 1: Pseudo	0
							X		Normal color mode shadow mask line color 0: Black 1: Overlay graphics pseudo color	0
	X	X	X	X	X	X			Reserved	-
129					X	X	X	X	Background pseudo color *as for the configurable color, please refer to color code chart	1
	X	X	X	X					Foreground pseudo color *as for the configurable color, please refer to color code chart	0
12A	X	X	X	X	X	X	X	X	Threshold for Pseudo color	48
12B	X	X	X	X	X	X	X	X	Slope for pseudo color slope	16
12C - 140	X	X	X	X	X	X	X	X	Reserved	-
141		X	X	X	X	X	X	X	Reserved	-
	X								Color / Monochrome 0: Color 1: Monochrome	0
142	0	X	X	X	X	X	X	X	R-Y gain Range: 0 to 127	28
143	0	X	X	X	X	X	X	X	B-Y gain Range: 0 to 127	28
144	X	X	X	X	X	X	X	X	R-Y hue * Two's compliment Range: -128 to 127	-12
145	X	X	X	X	X	X	X	X	B-Y hue * Two's compliment Range: -128 to 127	-29
146	X	X	X	X	X	X	X	X	Threshold for high brightness chroma suppression	240
146	X	X	X	X	X	X	X	X	slope for high brightness chroma suppression Range: 0 to 8	1
148					X	X	X	X	Aperture horizontal gain	3
	X	X	X	X					Aperture vertical gain	3
149	0	0	0	0	0	0	0	X	Aperture coring	2
14A - 15F	X	X	X	X	X	X	X	X	Reserved	-

Color Code Table

16 defined colors can be selected from following table and these colors can be referring to Line Marker.
As for User Defined Color 0 to 7, user can configure these colors setting through serial communication.

Code	Color
0	Black
1	White
2	Red
3	Green
4	Blue
5	Cyan
6	Magenta
7	Yellow
8	User Defined Color 0
9	User Defined Color 1
10	User Defined Color 2
11	User Defined Color 3
12	User Defined Color 4
13	User Defined Color 5
14	User Defined Color 6
15	User Defined Color 7

8.6 OSCD (On Screen Character Display) Command

8.6.1 2 Byte Command

Note: The data have to send as follow order D15-D8, D7-D0.

Function	D15	D14	D13	D12	D11	D10	D9	D8	D7	D6	D5	D4	D3	D2	D1	D0
Video RAM Batch Clear Command	0	0	0	0	0	0	0	0	0	0	0	0	0	0	0	0
Display Control Command	0	0	0	0	1	0	0	0	DO	0	FC	FA	0	0	BL1	BL0
Character Size Control Command	0	0	0	1	0	1	V4	V3	V2	V1	V0	H4	H3	H2	H1	H0
Write Address Control Command	0	0	0	1	1	1	0	AD8	AD7	AD6	AD5	AD4	AD3	AD2	AD1	AD0
Character Size Control Command	0	0	1	0	0	0	SV1	SV0	SH1	SH0	0	0	AR3	AR2	AR1	AR0

Video RAM Batch Clear Command

Clear the all character data (12Lines 28digits) on Video RAM.

Display, Framing color , Framing, Blinking, Frame Color and character size wii set as default (00H) on all lines.

Display Control Command

DO: Display (0:Display ON, 1:Display OFF)

FC: Frame color (0:Black, 1:White)

FA: Framing (0:ON, 1:OFF)

BL1, BL0: Blinking Frequency

(00: Blinking OFF, 01: Blinking Frequency approximately 2 Hz, 02: Blinking Frequency approximately 1 Hz,

03: Blinking Frequency approximately 0.5 Hz)

Character Size Control Command

Sets the start position. 32 steps / 8 dots unit on horizontal. 32 steps / 4 lines unit on vertical.

H4, H3, H2, H1, H0: 8 dots unit (0 to 31)

V4, V3, V2, V1, V0: 4 lines unit (0 to 31)

Write Address Control Command

AD8, AD7, AD6, AD5, AD4, AD3, AD2, AD1, AD0: Address (0 to 335)

Sets the address to write character.

The address consists of RAW 0 (Column 0 to 27), RAW 1 (Column 56 to 83) ... RAW11 (Column 308 to 335).

Character Size Control Command

Sets the character size for each row.

SV1, SV0: Size on Vertical (00: x1, 01: x2, 02: x3, 03: x4)

SH1, SH0: Size on Horizontal (00: x1, 01: x2, 02: x3, 03: x4)

AR3, AR2, AR1, AR0: Number of row (0 to 11)

8.6.2 2 Byte consecutive Command

Note: The data have to send as follow order D15-D8, D7-D0.

Function	D15	D14	D13	D12	D11	D10	D9	D8	D7	D6	D5	D4	D3	D2	D1	D0
Display Character Control Command	1	1	RV	R	G	B	BL	0	C7	C6	C5	C4	C3	C2	C1	C0

Display Character Control Command

Sets the writing character data, character color, blink data into Video RAM address.

This command is 2 Byte consecutive command, if more than 2 consecutive character writing are required, just send only lower 8bits (C7 to C0). The write address will be increased automatically.

When character control finishing, it is necessary to send 0xFF (End code of 2 Byte consecutive command).

RV: Reverse character color (0: OFF, 1: ON)

RGB: Character color (0: Black, 1: Blue, 2: Green, 3: Cyan, 4: Red, 5: Magenta, 6: Yellow, 7: White)

BL: Character blinks (0: No blinking, 1: Blinking)

C7-C0: Character code (please refer to the Character table as below)

C7 - C0	Character	C7 - C0	Character	C7 - C0	Character	C7 - C0	Character
000	sp	019	9	032	R	04B	k
001	!	01A	:	033	S	04C	l
002	"	01B	;	034	T	04D	m
003	#	01C	<	035	U	04E	n
004	\$	01D	=	036	V	04F	o
005	%	01E	>	037	W	050	p
006	&	01F	?	038	X	051	q
007	'	020	> fill	039	Y	052	r
008	(021	A	03A	Z	053	s
009)	022	B	03B	[054	t
00A	*	023	C	03C	¥	055	u
00B	+	024	D	03D]	056	v
00C	,	025	E	03E	< fill	057	w
00D	-	026	F	03F	△	058	x
00E	.	027	G	040	▽	059	y
00F	/	028	H	041	a	05A	z
010	0	029	I	042	b	05B	.
011	1	02A	J	043	c	05C	..
012	2	02B	K	044	d	05D	...
013	3	02C	L	045	e	05E	~
014	4	02D	M	046	f	05F	◆
015	5	02E	N	047	g	060	×
016	6	02F	O	048	h	061	÷
017	7	030	P	049	i	0FF	2 byte control finish
018	8	031	Q	04A	j		

9 Revisions History

Rev	Date	Changes	Note
00	2020/07/20	● New Document	
01	2020/09/09	● Revised Conformed WEEE	

Note: Product specifications would be changed without notification.

Company names and product names in this document are trademarks of their respective owners.

OMRON SENTECH CO., LTD.

19F, Ebina Prime Tower
9-50, Chuo 2 chome
Ebina-city, Kanagawa
243-0432 Japan
TEL 81-46-236-6660 FAX 81-46-236-6661
URL <http://www.sentech.co.jp/>